

---

# INSTALLATION INSTRUCTIONS

---

## LOW VOLTAGE CONTROL CIRCUIT WIRING

Models:

W\*\*A2 W\*\*A2D WA\*S\* W\*\*L2 WL\*S\*



Bard Manufacturing Company, Inc.  
Bryan, Ohio 43506  
[www.bardhvac.com](http://www.bardhvac.com)

Manual No.: 2100-582C  
Supersedes: 2100-582B  
Date: 12-2-14

# Contents

## Installation Instructions

Wiring – Low Voltage Wiring .....	3
Operating Voltage Range.....	3
Low Voltage Connection .....	3

## Tables

Table 1	Diagram to Use w/Unit & Vents.....	3
Table 2	Operating Voltage Range.....	3
Table 3	Wall Thermostat .....	4
Table 4	Humidity Controls.....	4
Table 5	CO <sub>2</sub> Controller .....	4
Table 6	Thermostat Wire Size.....	4

## Figures

Figure 1	Basic A/C with Optional Electric Heat No Economizer or Vent Packages .....	5
Figure 2	Opt. MFAD, CRV or ERV Vent. Pkg. w/ Programmable T-Stat .....	6
Figure 3	Opt. MFAD, CRV or ERV Vent. Pkg. w/ Non-Programmable T-Stat .....	7
Figure 4	A/C with Economizer .....	8
Figure 5	A/C w/Dehumidification Sequence & No Vent Pkg. ....	9
Figure 6	A/C w/Dehumidification Sequence & No Vent Pkg. Using Sep. Controls .....	10
Figure 7	A/C w/Dehumidification Sequence w/Vent Pkg. Using Combination Controller .....	11
Figure 8	A/C w/Dehumidification Sequence w/Vent Pkg. Using Non-Prog. T-Stat & Separate Humidity Controller .....	12
Figure 9	A/C w/Dehumidification Sequence & Economizer .....	13

Figure 10	A/C w/Dehumidification Sequence & Economizer w/Combination Temperature & Humidity Control .....	14
Figure 11	A/C w/CS2000 Wiring Diagram .....	15
Figure 12	2-Stage A/C with Optional Electric Heat – No Economizer or Vent Pkgs. ....	16
Figure 13	2-Stage A/C Opt. MFAD or ERV Vent. Pkg. w/Non-Programmable T-Stat.....	17
Figure 14	2-Stage A/C Opt. MFAD or ERV Vent. Pkg. w/Programmable T-Stat .....	18
Figure 15	2-Stage A/C with Economizer .....	19
Figure 16	2-Stage A/C w/Opt. CRVMP Low Voltage . Wiring .....	20
Figure 17	1-Stage A/C w/Opt. Elec. Heat w/ ECONWM* Style Economizer .....	21
Figure 18	2-Stage A/C w/Opt. Elec. Heat w/ ECONWM* Style Economizer .....	22

**TABLE 1 — DIAGRAM TO USE WITH UNIT AND VENTS**

	Vent	None		CRV, ERV, MFAD		CRVMP	EIFM		ECONWM*	CS2000A*
	Vent Code	X		R,M,V,P		C	E		T,W	
	Thermostat	Programmable		Programmable		ALL	Programmable		ALL	ALL
System Type	Model	No	Yes	No	Yes	All	No	Yes	All	All
Air Conditioner	W**A, W**L	1	1	3	2	N/A	4	4	17	11
Air Conditioner w/Dehumidification Sequence	W**A*D W**L*D	6	5	8	7	N/A	9	10	N/A	11
2-Stage Air Conditioner	WA*S* WL*S*	12	12	13	14	16	15	15	18	11

**WIRING – LOW VOLTAGE WIRING**

All 230/208V, 1 phase and 3 phase units are equipped with dual primary voltage transformers. All equipment leaves the factory wired on 240V tap. For 208V operation, reconnect from 240V to 208V tap. The acceptable operating voltage range for the 240V and 208V taps are:

An 18 gauge copper, color-coded thermostat cable is recommended. The connection points are shown in this Manual. See Table below.

**TABLE 2 – OPERATING VOLTAGE RANGE**

TAP	RANGE
240V	253 – 216
208V	220 – 187

*NOTE: The voltage should be measured at the field power connection point in the unit and while the unit is operating at full load (maximum amperage operating condition).*

**Low Voltage Connection**

These units use a 24-volt AC low voltage circuit. The “RT” terminal is the 24V transformer output, and the “R” terminal is the 24VAC hot terminal for the operation of the equipment. “RT” and “R” are connected with brass jumper bar which can be removed and “RT” and “R” connected to external NC (normally closed) contact such as a fire/smoke detector that will cause immediate shutdown of the equipment upon activation.

“C” terminal is grounded.

“G” terminal is the fan input.

“Y” terminal is the compressor input for cooling 1-Stage units only or 2-Stage units with ECONWM\*

“Pink Wire” is 2nd Stage cooling 2-Stage units only with ECONWM\*

“Y1” terminal is the 1st Stage compressor input for cooling 2-Stage units only — No ECONWM\*

“Y2” terminal is the 2nd Stage compressor input for cooling 2-Stage units only — No ECONWM\*

“W1” terminal is the 1st stage electric heat.

“W2” terminal is the 2nd stage heat (if equipped).

“A” terminal is the ventilation input. This terminal energizes any factory installed ventilation option.

“D” terminal is the dehumidification input. If installed, this terminal energizes any factory installed dehumidification option.

**LOW VOLTAGE CONNECTIONS FOR DDC CONTROL**

	<u>1-Stage Units</u>	<u>2-Stage Units</u>	<u>2-Stage Units w/ECONWM*</u>
Fan Only	Energize G	Energize G	Energize G
1st Stage Cooling Mode	Energize Y, G	Energize Y1, G	Energize G, Y
2nd Stage Cooling Mode		Energize Y1, Y2, G	Energize G, Y, Pink
1st Stage Heating	Energize W1	Energize W1	Energize W1
2nd Stage Heating (if employed)	Energize W1, W2	Energize W1, W2	Energize W1, W2
Ventilation	Energize G, A	Energize G, A	Energize G, A
Dehumidification (if employed)	Energize D	Energize D	Energize D

**TABLE 3  
WALL THERMOSTAT**

Part Number	Predominate Features
8403-057 (TH3110D1040)	1 stage Cool, 1 stage Heat Electronic Non-Programmable Auto or Manual changeover
8403-058 (TH5220D1151)	2 stage Cool, 2 stage Heat Electronic Non-Programmable HP or Conventional (Default: HP) Auto or Manual changeover
8403-059 (TH5220D1219/U)	2 stage Cool, 2 stage Heat Electronic Non-Programmable HP or Conventional (Default: AC) Auto or Manual changeover
8403-060 (1120-445)	3 stage Cool; 3 stage Heat Programmable/Non-Programmable Electronic HP or Conventional Auto or Manual changeover Dehumidification Output

**TABLE 4  
HUMIDITY CONTROLS**

Part Number	Predominate Features
8403-038 (H600A1014)	SPDT switching, pilot duty 50VA @ 24V Humidity range 20-80% RH
8403-047 (H200-10-21-10)	Electronic dehumidstat SPST closes-on-rise Humidity range 10-90% with adjustable stops

**TABLE 5  
CO2 CONTROLLER**

Part Number	Predominate Features
8403-067	Normally Open SPST relay closes-on-rise 24V dual wave length sensor. Default setting 950ppm, adjustable to 0-2000ppm Default off setting 1000ppm, adjustable to 0-200 ppm can be calibrated

**TABLE 6  
THERMOSTAT WIRE SIZE**

Transformer VA	FLA	Wire Gauge	Maximum Distance In Feet
55	2.3	20 gauge	45
		18 gauge	60
		16 gauge	100
		14 gauge	160
		12 gauge	250

**FIGURE 1**  
**BASIC A/C with OPTIONAL ELECTRIC HEAT**  
**NO ECONOMIZER or VENTILATION PACKAGES**

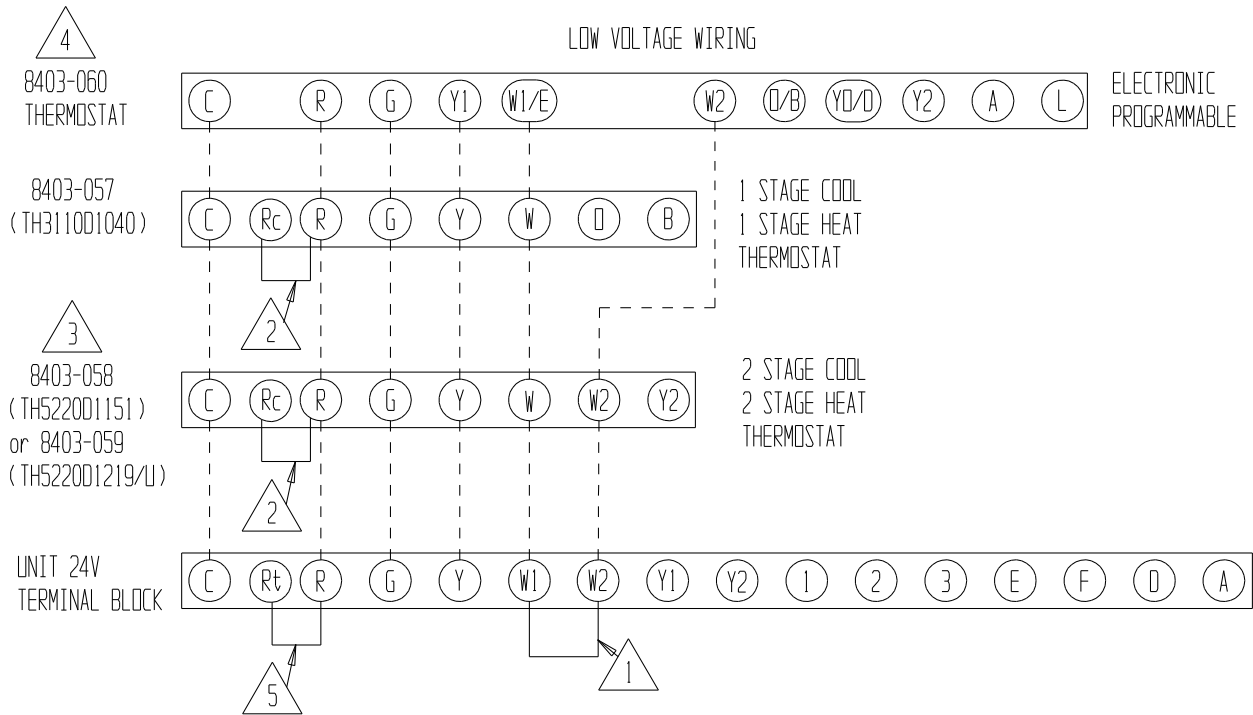

REMOVE JUMPER FOR 2 STAGE ELECTRIC HEAT ON UNITS WITH 15 OR MORE KW



FACTORY INSTALLED JUMPER



FOR 8403-058, CHANGE "SYSTEM TYPE", SET UP FUNCTION 1, FROM 5 (2 HEAT/ 1 COOL HEAT PUMP) TO 6 (2 HEAT/ 2 COOL CONVENTIONAL). FOR 8403-059, NO CHANGE REQUIRED



CHANGE MODEL CONFIGURATION FROM HEAT PUMP TO HEAT/COOL.



FACTORY INSTALLED JUMPER. FOR IMMEDIATE EMERGENCY SHUTDOWN OF ALL HVAC OPERATION, REMOVE JUMPER AND CONNECT NORMALLY CLOSED (NC) CONTACT TO R AND R<sub>t</sub> TERMINALS.

MIS-3138 A

**FIGURE 2**  
**OPTIONAL MFAD, CRV or ERV VENTILATION PACKAGES**  
**with PROGRAMMABLE THERMOSTAT (RECOMMENDED)**

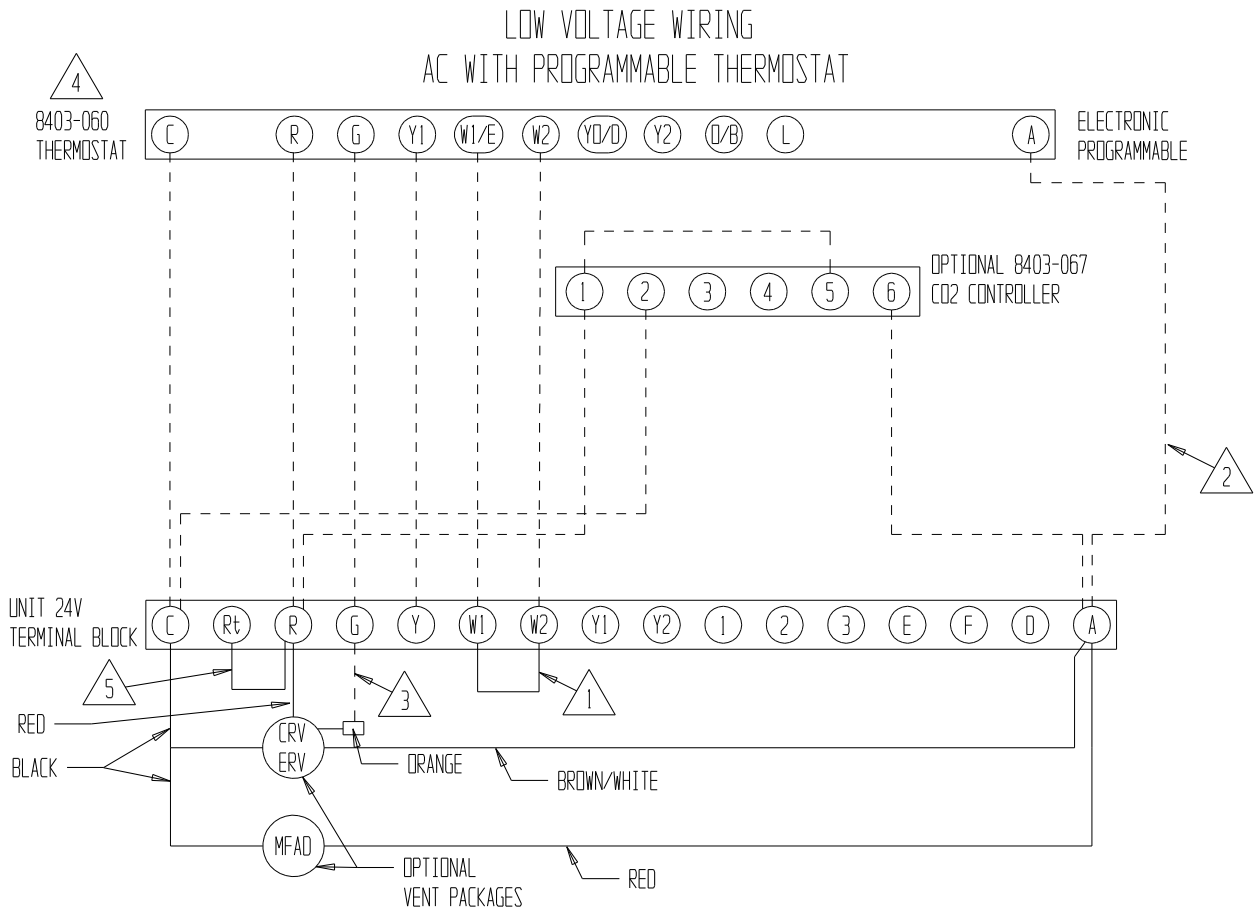

MIS-3139 A

- 1** REMOVE JUMPER FOR 2 STAGE ELECTRIC HEAT ON UNITS WITH 15 OR MORE KW
- 2** DO NOT CONNECT "A" FROM 8403-060 IF OPTIONAL CO<sub>2</sub> CONTROLLER IS USED
- 3** CONNECT ORANGE WIRE TO "G" ONLY IF OPTIONAL CO<sub>2</sub> CONTROLLER IS USED
- 4** CHANGE MODEL CONFIGURATION FROM HEAT PUMP TO HEAT/COOL. MUST BE CONFIGURED TO PROGRAMMABLE AND FAN SET TO PROGRAMMED FAN FOR THE "A" OUTPUT TO FUNCTION DURING SCHEDULED OCCUPIED PERIODS.
- 5** FACTORY INSTALLED JUMPER. FOR IMMEDIATE EMERGENCY SHUTDOWN OF ALL HVAC OPERATION, REMOVE JUMPER AND CONNECT NORMALLY CLOSED (NC) CONTACT TO R AND Rt TERMINALS.





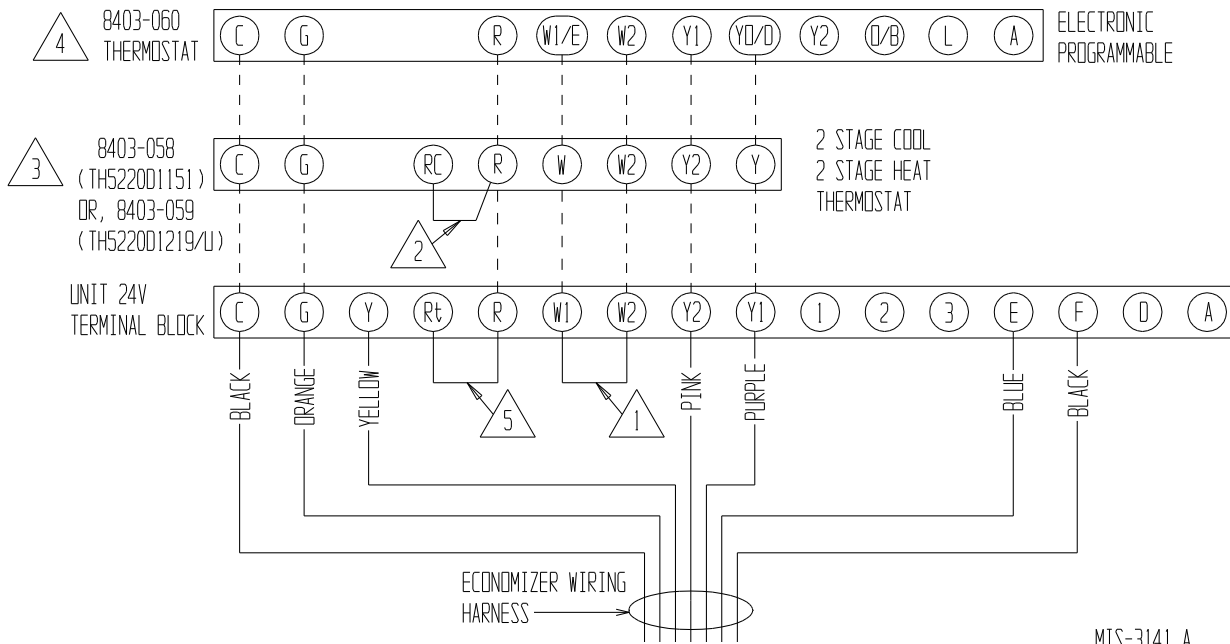

**FIGURE 4  
A/C with EIFM**

OPTIONAL ECONOMIZER LOW VOLTAGE WIRING



MIS-3141 A

-  REMOVE JUMPER FOR 2 STAGE ELECTRIC HEAT ON UNITS WITH 15 OR MORE KW
-  FACTORY INSTALLED JUMPER
-  FOR 8403-058, CHANGE "SYSTEM TYPE", SET UP FUNCTION 1, FROM 5 (2 HEAT/ 1 COOL HEAT PUMP) TO 6 (2 HEAT/ 2 COOL CONVENTIONAL). FOR 8403-059, NO CHANGE
-  CHANGE MODEL CONFIGURATION FROM HEAT PUMP TO HEAT/COOL, AND MUST BE CONFIGURED FOR ECONOMIZER FOR YD/D OUTPUT TO BE ACTIVE AS FIRST STAGE COOLING.
-  FACTORY INSTALLED JUMPER. FOR IMMEDIATE EMERGENCY SHUTDOWN OF ALL HVAC OPERATION, REMOVE JUMPER AND CONNECT NORMALLY CLOSED (NC) CONTACT TO R AND Rt TERMINALS.



**FIGURE 5**  
**A/C with DEHUMIDIFICATION SEQUENCE**  
**& NO VENTILATION PACKAGE USING**  
**8403-060 COMBINATION TEMPERATURE and HUMIDITY CONTROLLER**

LOW VOLTAGE WIRING

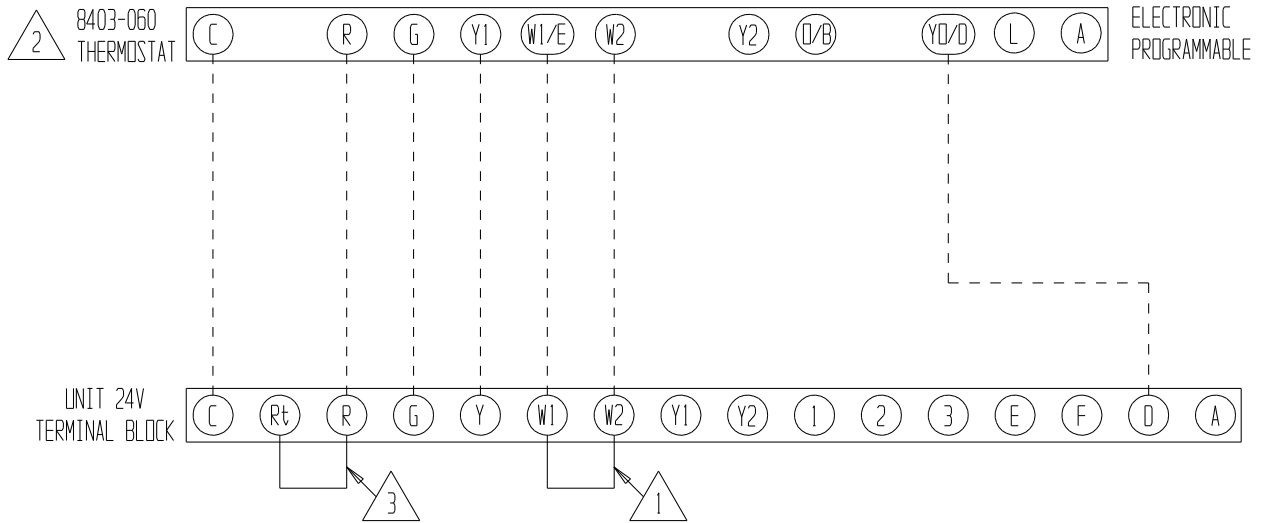

**1** REMOVE JUMPER FOR 2 STAGE ELECTRIC HEAT ON UNITS WITH 15 OR MORE KW

MIS-3142

**2** CHANGE MODEL CONFIGURATION FROM HEAT PUMP TO HEAT/COOL, AND MUST BE CONFIGURED FOR "NO ECONOMIZER" TO MAKE YO/D OUTPUT ACTIVE FOR HUMIDITY CONTROL



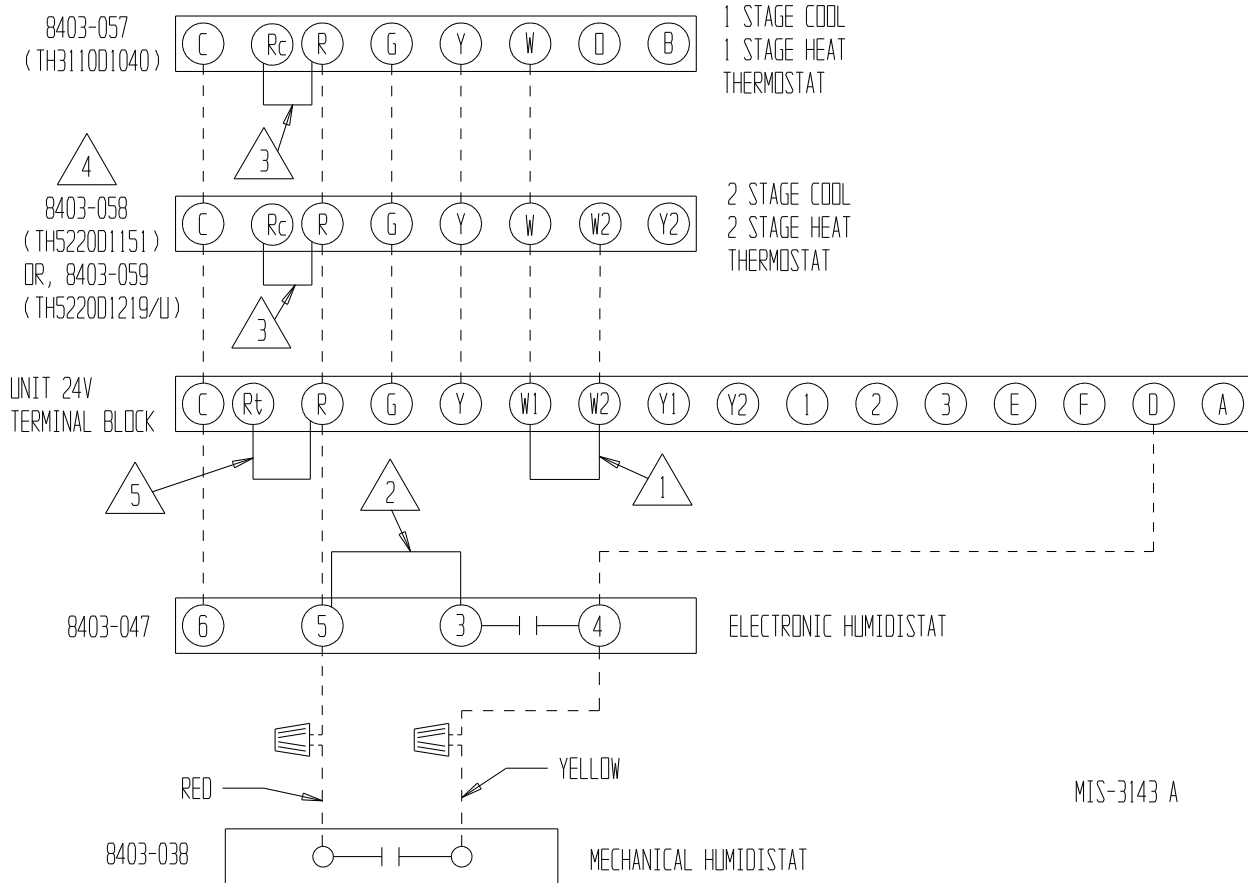

**3** FACTORY INSTALLED JUMPER. FOR IMMEDIATE EMERGENCY SHUTDOWN OF ALL HVAC OPERATION, REMOVE JUMPER AND CONNECT NORMALLY CLOSED (NC) CONTACT TO R AND R<t TERMINALS.

**FIGURE 6**  
**A/C with DEHUMIDIFICATION SEQUENCE**  
**& NO VENTILATION PACKAGE USING SEPARATE**  
**TEMPERATURE and HUMIDITY CONTROLS**

LOW VOLTAGE WIRING



MIS-3143 A

-  REMOVE JUMPER FOR 2 STAGE ELECTRIC HEAT ON UNITS WITH 15 OR MORE KW
-  JUMPER NEEDS TO BE ADDED
-  FACTORY INSTALLED JUMPER
-  FOR 8403-058, CHANGE "SYSTEM TYPE", SET UP FUNCTION 1, FROM 5 (2 HEAT/ 1 COOL HEAT PUMP) TO 6 (2 HEAT/ 2 COOL CONVENTIONAL). FOR 8403-059, NO CHANGE
-  FACTORY INSTALLED JUMPER. FOR IMMEDIATE EMERGENCY SHUTDOWN OF ALL HVAC OPERATION, REMOVE JUMPER AND CONNECT NORMALLY CLOSED (NC) CONTACT TO R AND Rt TERMINALS.

**FIGURE 7**  
**A/C with DEHUMIDIFICATION SEQUENCE**  
**with VENTILATION PACKAGE USING**  
**8403-060 COMBINATION TEMPERATURE & HUMIDITY CONTROLLER**  
**and 8403-067 CO<sub>2</sub> CONTROLLER**

LOW VOLTAGE WIRING

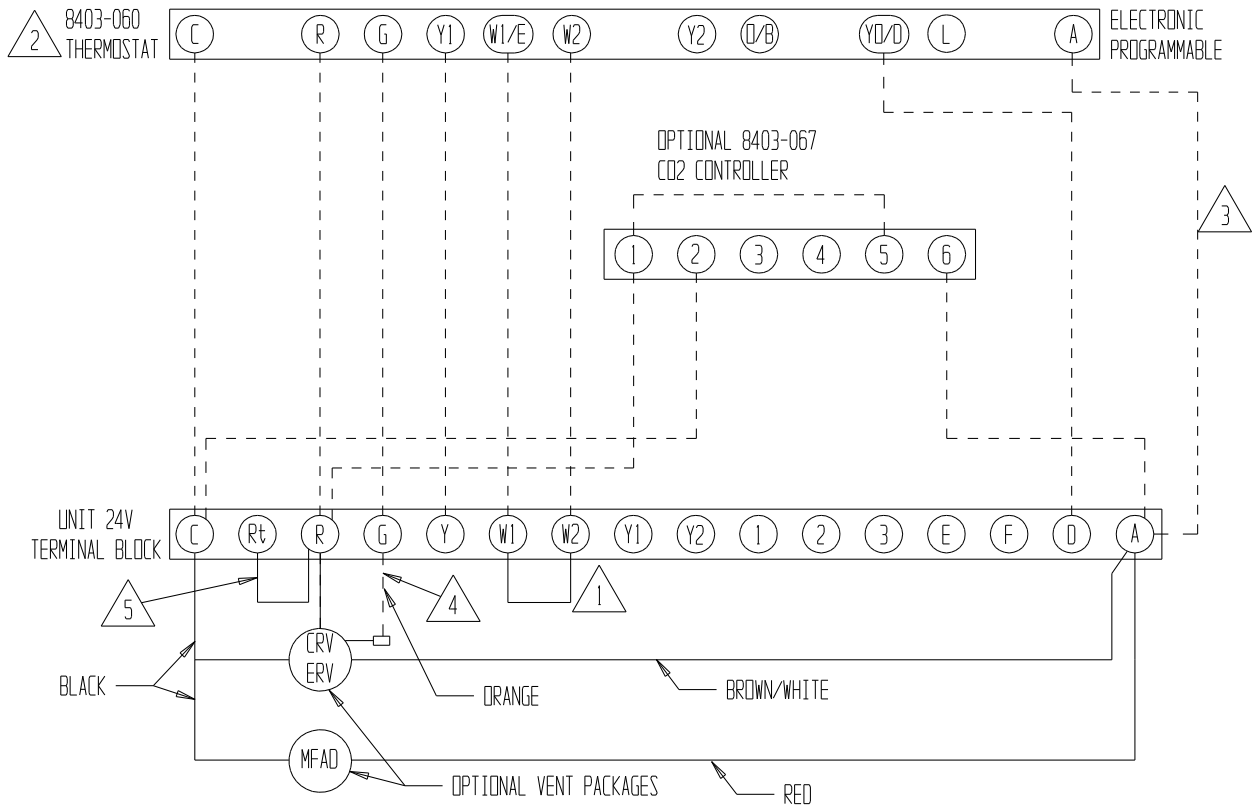

1 REMOVE JUMPER FOR 2 STAGE ELECTRIC HEAT ON UNITS WITH 15 OR MORE KW

MIS-3144

2 CHANGE MODEL CONFIGURATION FROM HEAT PUMP TO HEAT/COOL, AND MUST BE CONFIGURED FOR "NO ECONOMIZER" TO MAKE YD/D OUTPUT ACTIVE FOR HUMIDITY CONTROL

3 DO NOT CONNECT "A" FROM 8403-060 IF OPTIONAL CO<sub>2</sub> CONTROLLER IS USED

4 CONNECT ORANGE WIRE TO "G" ONLY IF OPTIONAL CO<sub>2</sub> CONTROLLER IS USED.

5 FACTORY INSTALLED JUMPER. FOR IMMEDIATE EMERGENCY SHUTDOWN OF ALL HVAC OPERATION, REMOVE JUMPER AND CONNECT NORMALLY CLOSED (NC) CONTACT TO R AND Rt TERMINALS.

**FIGURE 8**  
**A/C with DEHUMIDIFICATION SEQUENCE**  
**with VENTILATION PACKAGE USING**  
**NON-PROGRAMMABLE THERMOSTAT**  
**and SEPARATE HUMIDITY CONTROLLER**

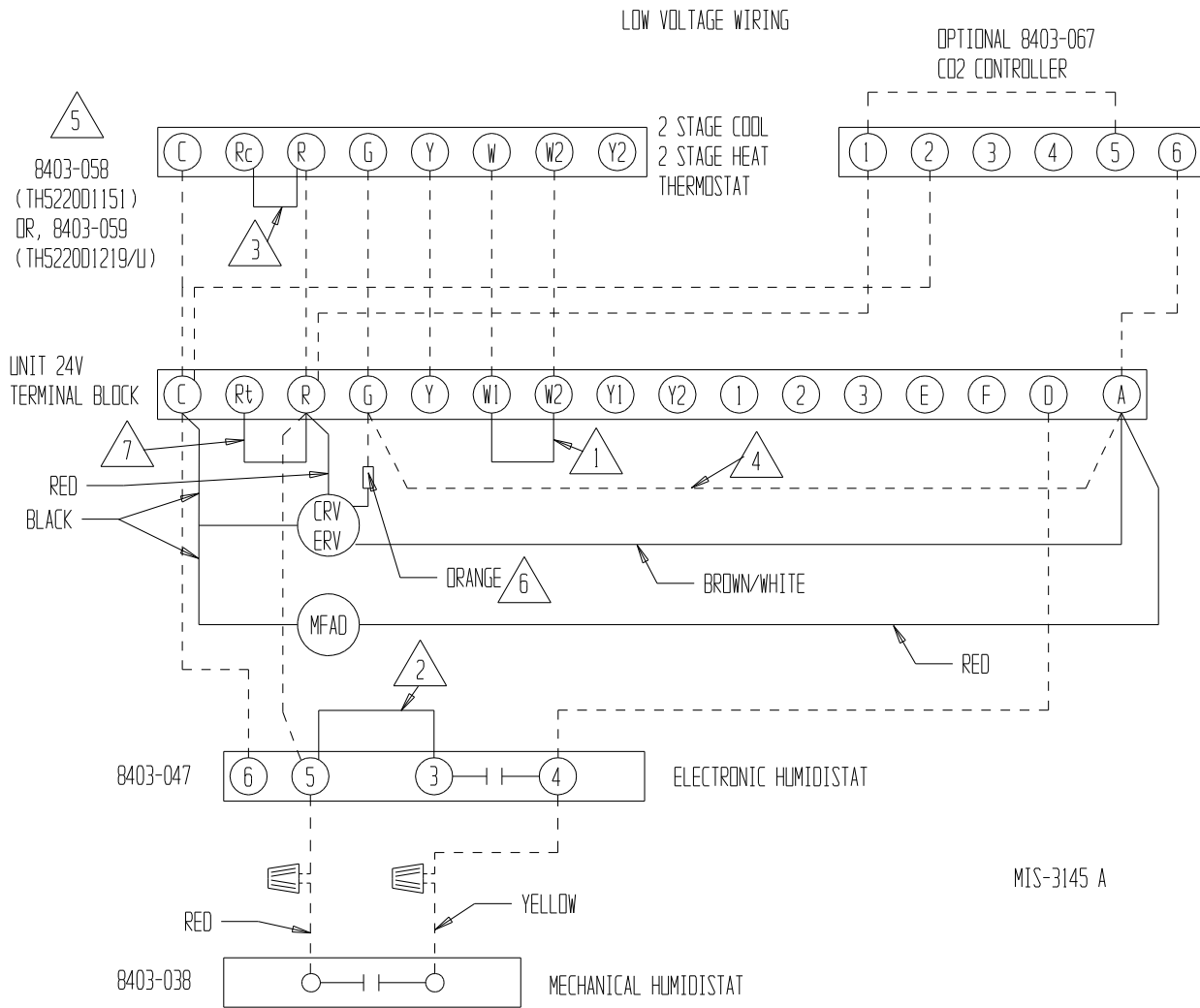



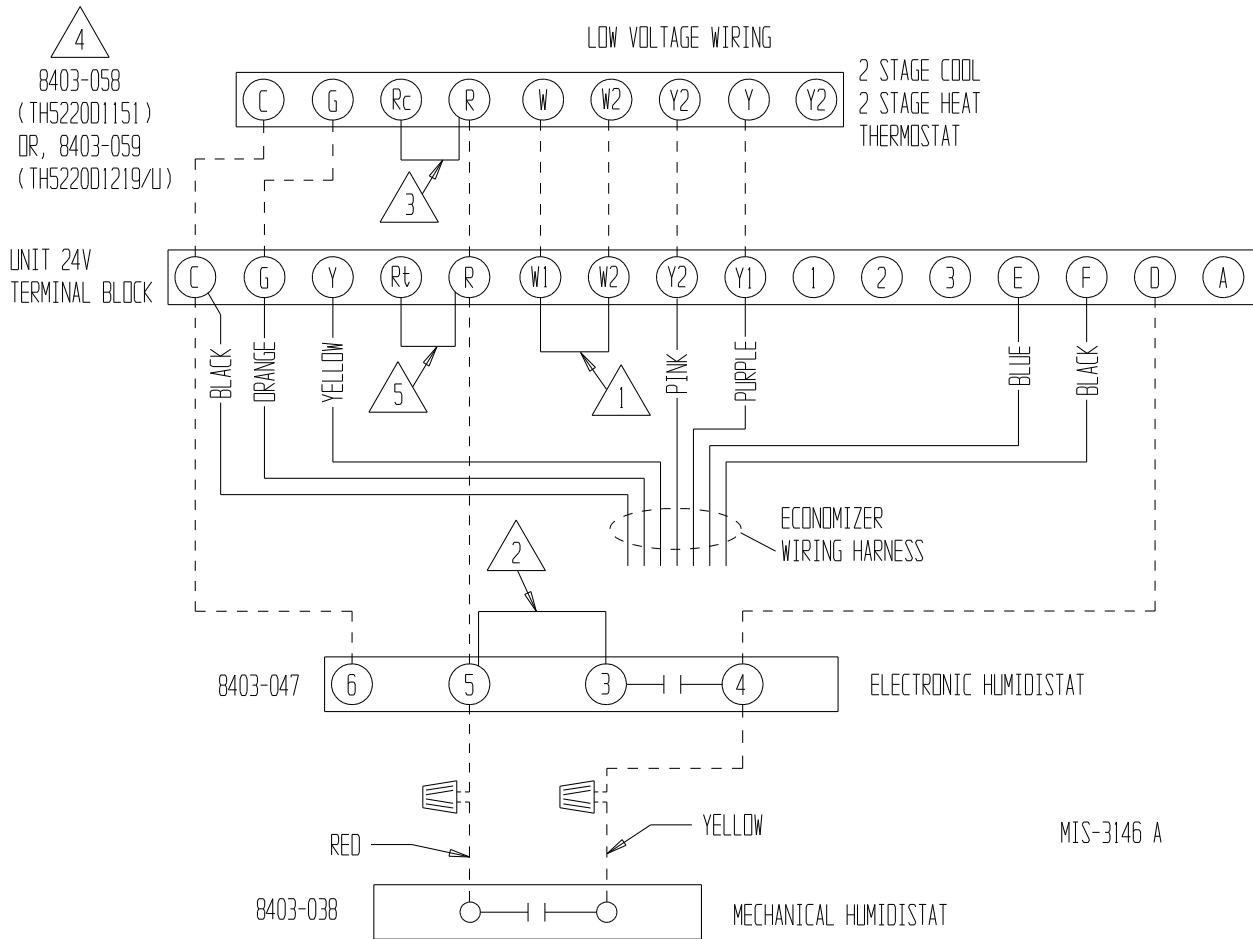

MIS-3145 A

- 1 REMOVE JUMPER FOR 2 STAGE ELECTRIC HEAT ON UNITS WITH 15 OR MORE KW
- 2 JUMPER NEEDS TO BE ADDED
- 3 FACTORY INSTALLED JUMPER
- 4 ADD JUMPER IF OPTIONAL CO2 CONTROLLER IS NOT USED. VENT WILL RUN WHILE BLOWER IS ENERGIZED, IF CO2 CONTROLLER IS INSTALLED, DO NOT ADD JUMPER AND SEE NOTE 6.
- 5 FOR 8403-058, CHANGE "SYSTEM TYPE", SET UP FUNCTION 1, FROM 5 (2 HEAT/ 1 COOL HEAT PUMP) TO 6 (2 HEAT/ 2 COOL CONVENTIONAL). FOR 8403-059, NO CHANGE
- 6 CONNECT ORANGE WIRE TO "G" ONLY IF OPTIONAL CO2 CONTROLLER IS INSTALLED.
- 7 FACTORY INSTALLED JUMPER. FOR IMMEDIATE EMERGENCY SHUTDOWN OF ALL HVAC OPERATION, REMOVE JUMPER AND CONNECT NORMALLY CLOSED (NC) CONTACT TO R AND Rt TERMINALS.

**FIGURE 9**  
**A/C with DEHUMIDIFICATION SEQUENCE**  
**& EIFM with 8403-058 THERMOSTAT**  
**and 8403-038 or 8403-047 HUMIDISTAT**



MIS-3146 A

-  REMOVE JUMPER FOR 2 STAGE ELECTRIC HEAT ON UNITS WITH 15 OR MORE KW
-  JUMPER NEEDS TO BE ADDED
-  FACTORY INSTALLED JUMPER
-  FOR 8403-058, CHANGE "SYSTEM TYPE", SET UP FUNCTION 1, FROM 5 (2 HEAT/ 1 COOL HEAT PUMP) TO 6 (2 HEAT/ 2 COOL CONVENTIONAL). FOR 8403-059, NO CHANGE
-  FACTORY INSTALLED JUMPER. FOR IMMEDIATE EMERGENCY SHUTDOWN OF ALL HVAC OPERATION, REMOVE JUMPER AND CONNECT NORMALLY CLOSED (NC) CONTACT TO R AND Rt TERMINALS.

**FIGURE 10**  
**A/C with DEHUMIDIFICATION SEQUENCE**  
**& EIFM with 8403-060**  
**COMBINATION TEMPERATURE and HUMIDITY CONTROL**

**LOW VOLTAGE WIRING**

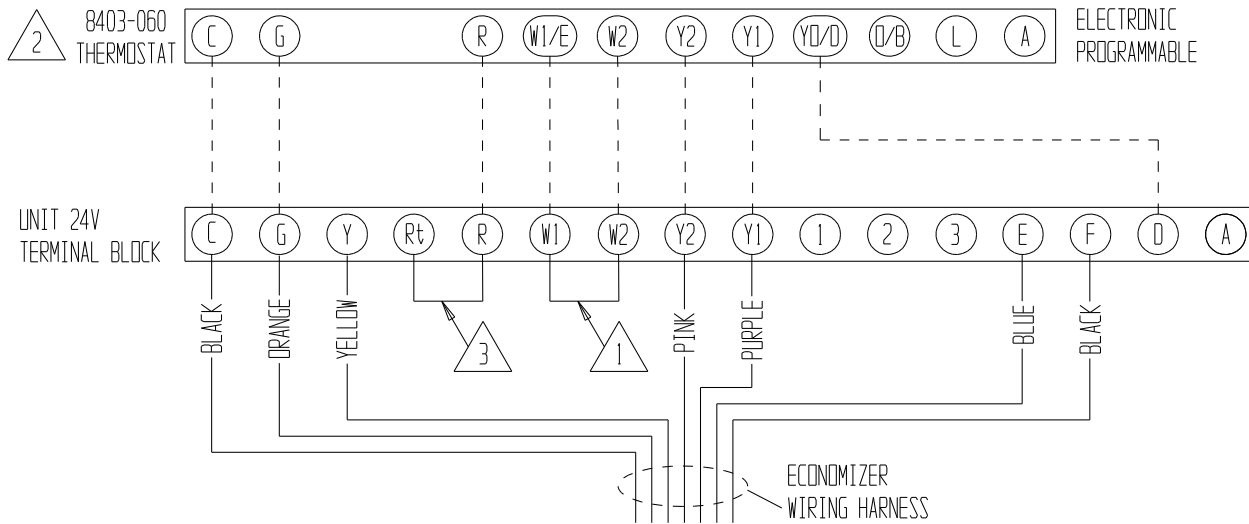

MIS-3147

- 1** REMOVE JUMPER FOR 2 STAGE ELECTRIC HEAT ON UNITS WITH 15 OR MORE KW
- 2** CHANGE MODEL CONFIGURATION FROM HEAT PUMP TO HEAT/COOL, AND MUST BE CONFIGURED FOR NO ECONOMIZER AND MULTI-STAGE FOR Y1 OUTPUT TO BE ACTIVE AS FIRST STAGE COOLING AND YD/D TO BE ACTIVE FOR HUMIDITY CONTROL
- 3** FACTORY INSTALLED JUMPER. FOR IMMEDIATE EMERGENCY SHUTDOWN OF ALL HVAC OPERATION, REMOVE JUMPER AND CONNECT NORMALLY CLOSED (NC) CONTACT TO R AND Rt TERMINALS.

**FIGURE 11**

**AIR CONDITIONER WITH CS2000**

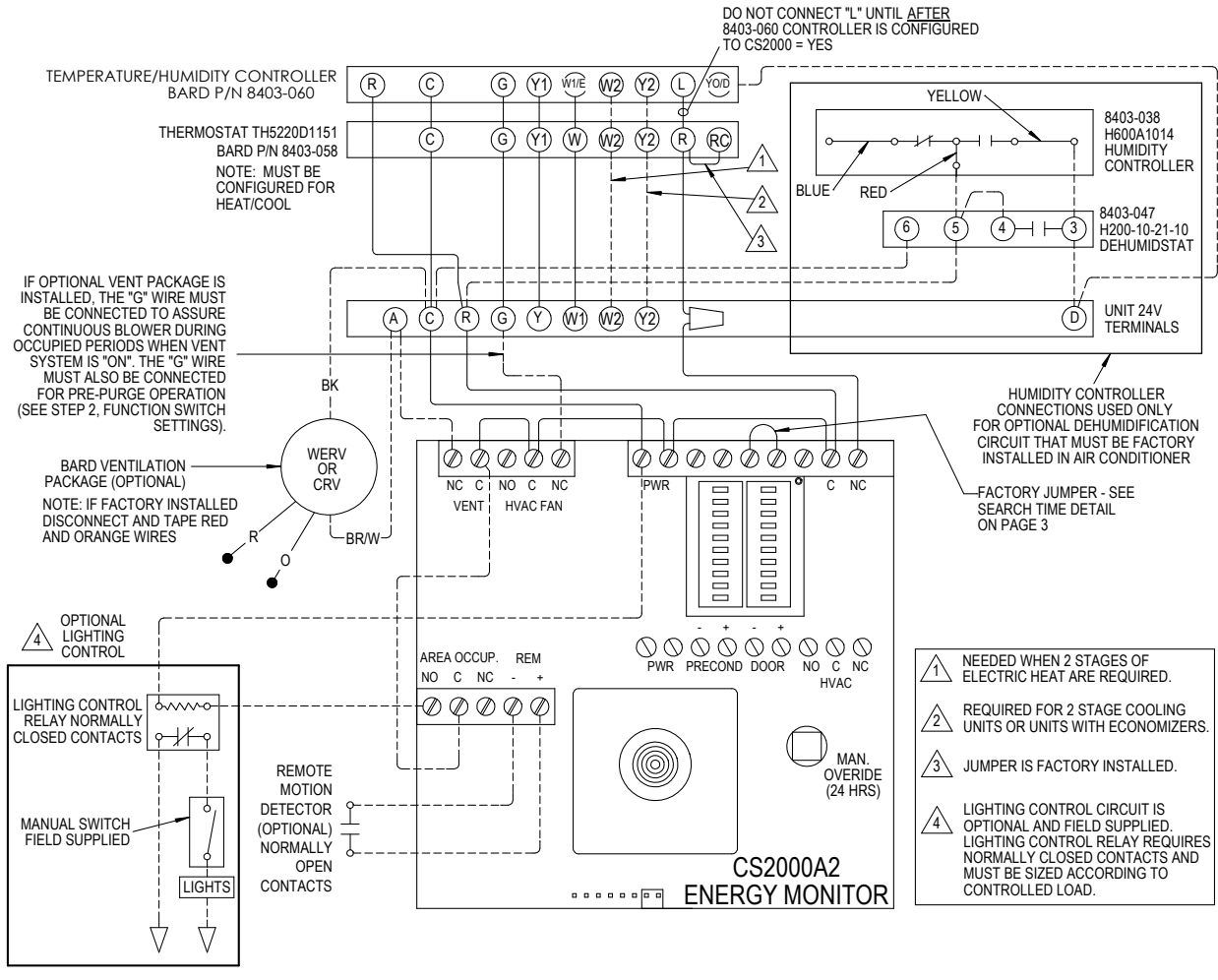

**RECOMMENDED SWITCH SETTINGS SHOWN BELOW**

FUNCTION SWITCHES		TEMPERATURE SWITCHES	
LEARN			90
PRE P			84
MODE			81
RATE			78
SEARCH-TIME			68
N/C			65
STAGE			62
AUX			58
DEMAND 2			54
DEMAND 1			48

4093-157

**FIGURE 12**  
**2-STAGE A/C with OPTIONAL ELECTRIC HEAT**  
**NO ECONOMIZER or VENTILATION PACKAGES**

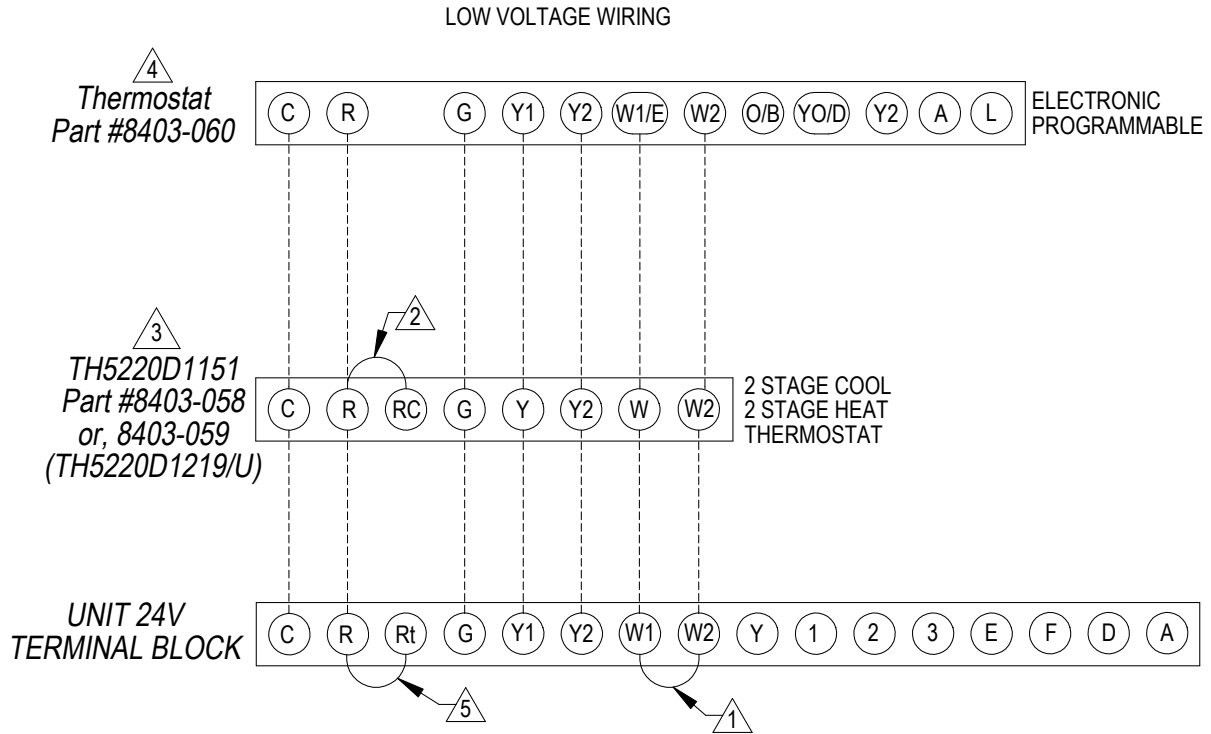

**1** REMOVE JUMPER FOR 2 STAGE ELECTRIC HEAT ON UNITS WITH 15 OR MORE KW

MIS-3148 A

**2** FACTORY INSTALLED JUMPER

**3** FOR 8403-058, CHANGE "SYSTEM TYPE". SET UP FUNCTION 1, FROM 5 (2 HEAT/ 1 COOL HEAT PUMP) TO 6 (2 HEAT/ 2 COOL CONVENTIONAL) FOR 8403-059, NO CHANGE.

**4** CHANGE MODEL CONFIGURATION FROM HEAT PUMP TO HEAT/COOL

**5** FACTORY INSTALLED JUMPER. FOR IMMEDIATE EMERGENCY SHUTDOWN OF ALL HVAC OPERATION, REMOVE JUMPER AND CONNECT NORMALLY CLOSED (NC) CONTACT TO R AND Rt TERMINALS.



**FIGURE 13**  
**2-STAGE A/C with OPTIONAL MFAD OR ERV VENTILATION PACKAGES**  
**with NON-PROGRAMMABLE THERMOSTAT**

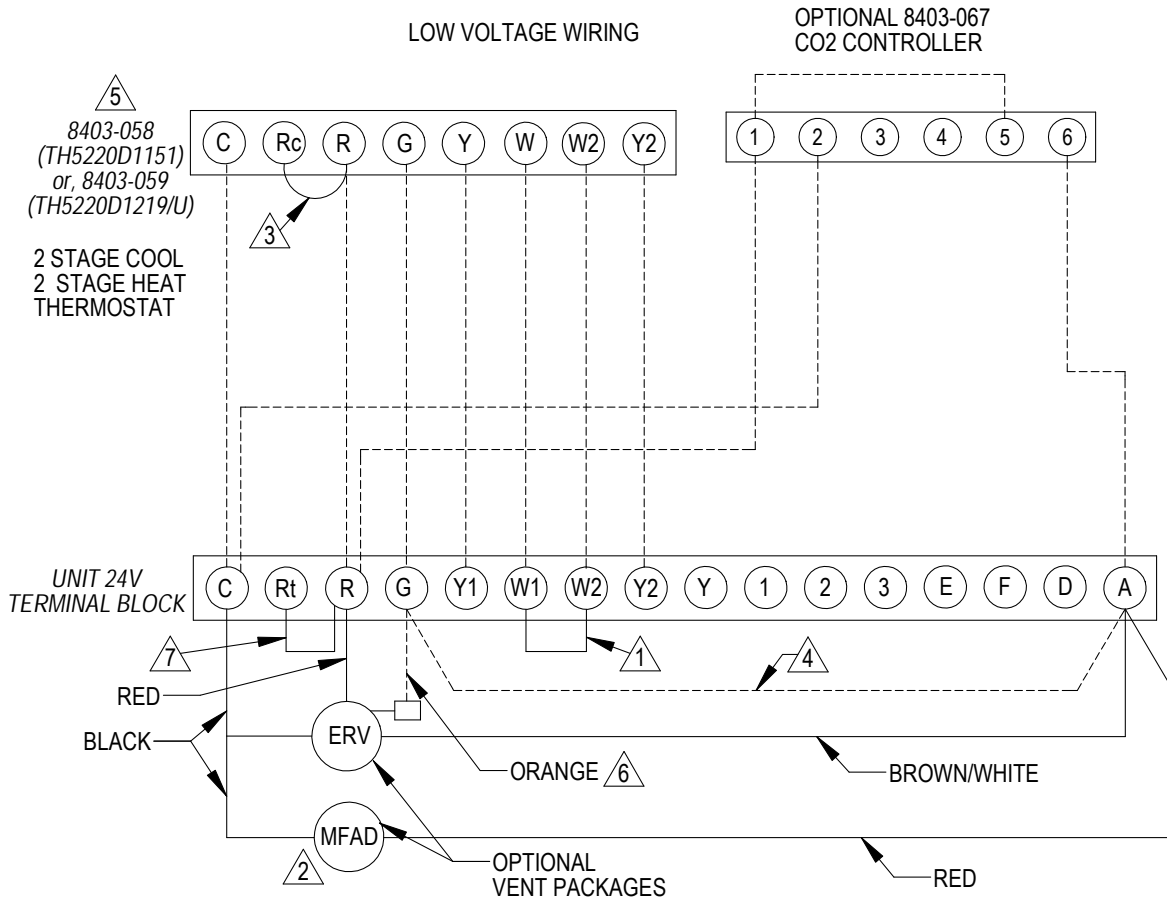

1 REMOVE JUMPER FOR 2 STAGE ELECTRIC HEAT ON UNITS WITH 15 OR MORE KW

MIS-3149 A

2 OPTIONAL VENT OPTION SUGGESTED HOOK UP

3 FACTORY INSTALLED JUMPER

4 ADD JUMPER IF OPTIONAL CO2 CONTROLLER IS NOT USED, VENT WILL RUN WHILE BLOWER IS ENERGIZED. DO NOT INSTALL JUMPER IF OPTIONAL CO2 CONTROLLER INSTALLED, AND SEE NOTE 6.

5 FOR 8403-058, CHANGE "SYSTEM TYPE", SET UP FUNCTION 1, FROM 5 (2 HEAT/ 1 COOL HEAT PUMP) TO 6 (2 HEAT / 2 COOL CONVENTIONAL). FOR 8403-059, NO CHANGE.

6 CONNECT ORANGE WIRE TO "G" ONLY IF OPTIONAL CO2 CONTROLLER IS INSTALLED.

7 FACTORY INSTALLED JUMPER. FOR IMMEDIATE EMERGENCY SHUTDOWN OF ALL HVAC OPERATION, REMOVE JUMPER AND CONNECT NORMALLY CLOSED (NC) CONTACT TO R AND Rt TERMINALS.

**FIGURE 14**  
**2-STAGE A/C with OPTIONAL MFAD OR ERV VENTILATION PACKAGES**  
**with PROGRAMMABLE THERMOSTAT (RECOMMENDED)**

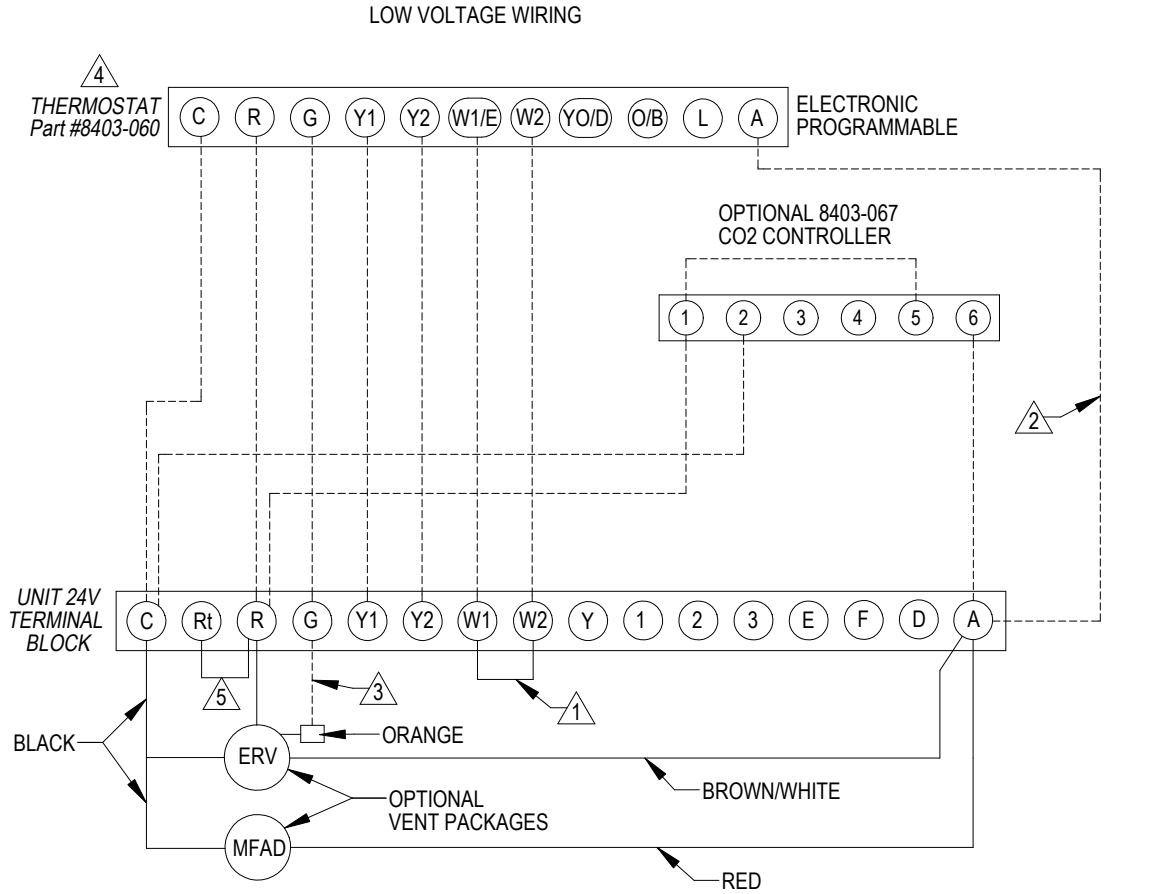

- 1 REMOVE JUMPER FOR 2 STAGE ELECTRIC HEAT ON UNITS WITH 15 OR MORE KW
- 2 DO NOT CONNECT "A" FROM 8403-060 IF OPTIONAL CO2 CONTROLLER IS USED
- 3 CONNECT ORANGE WIRE TO "G" ONLY IF OPTIONAL CO2 CONTROLLER IS USED
- 4 CHANGE MODEL CONFIGURATION FROM HEAT PUMP TO HEAT/COOL. MUST BE CONFIGURED TO PROGRAMMABLE AND FAN SET TO PROGRAMMED FAN FOR THE "A" OUTPUT TO FUNCTION DURING SCHEDULED OCCUPIED PERIODS.
- 5 FACTORY INSTALLED JUMPER. FOR IMMEDIATE EMERGENCY SHUTDOWN OF ALL HVAC OPERATION, REMOVE JUMPER AND CONNECT NORMALLY CLOSED (NC) CONTACT TO R AND Rt TERMINALS.

MIS-3150

**FIGURE 15**  
**2-STAGE A/C with EIFM**

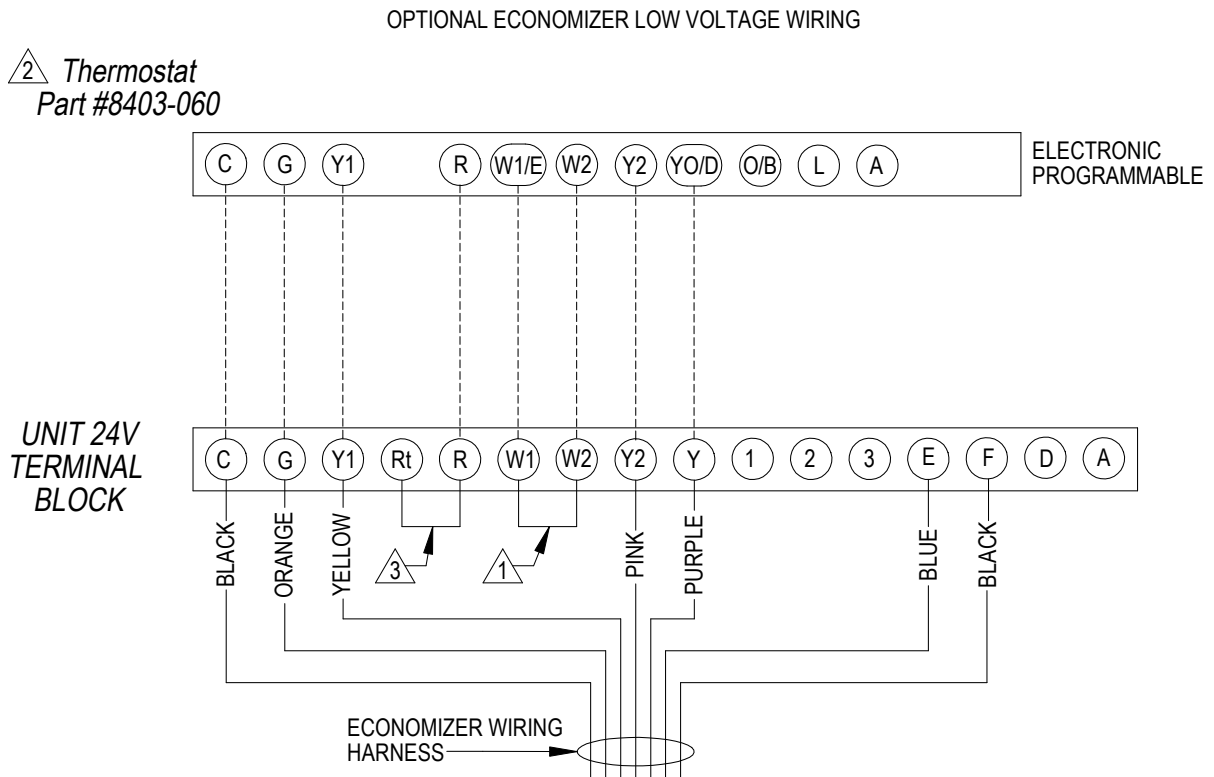

MIS-3151

- 1 REMOVE JUMPER FOR 2 STAGE ELECTRIC HEAT ON UNITS WITH 15 OR MORE KW
- 2 CHANGE MODEL CONFIGURATION FROM HEAT PUMP TO HEAT/COOL, AND MUST BE CONFIGURED FOR ECONOMIZER FOR YO/D OUTPUT TO BE ACTIVE AS FIRST STAGE COOLING.
- 3 FACTORY INSTALLED JUMPER. FOR IMMEDIATE EMERGENCY SHUTDOWN OF ALL HVAC OPERATION, REMOVE JUMPER AND CONNECT NORMALLY CLOSED (NC) CONTACT TO R AND Rt TERMINALS.

**FIGURE 16**  
**2-STAGE A/C with OPTIONAL CRVMP LOW VOLTAGE WIRING**

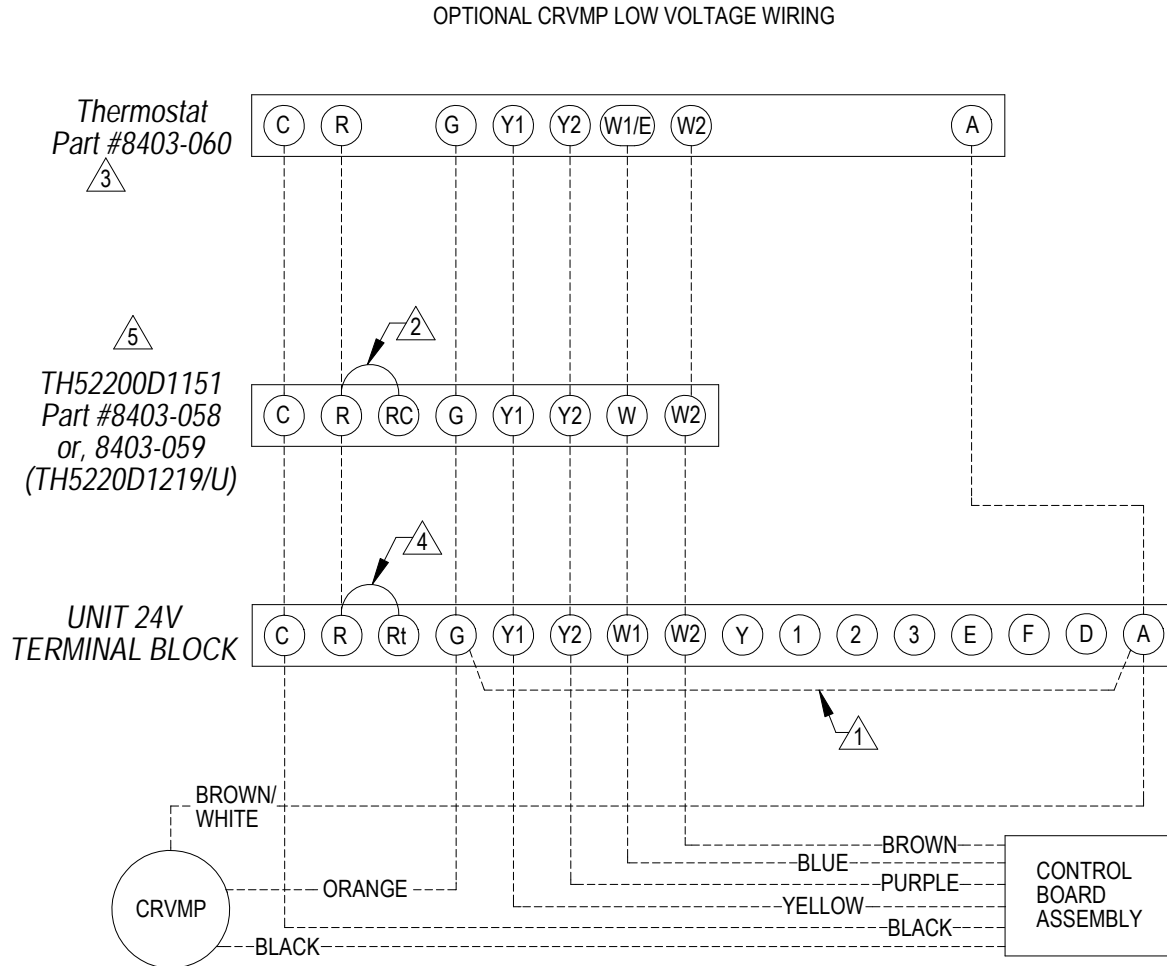

MIS-3152 A

- ① INSTALL JUMPER WHEN USING THERMOSTAT PART #8403-058
- ② FACTORY INSTALLED JUMPER
- ③ CHANGE MODEL CONFIGURATION FROM HEAT PUMP TO HEAT/COOL. MUST BE CONFIGURED TO PROGRAMMABLE AND FAN SET TO PROGRAMMED FAN FOR THE "A" OUTPUT TO FUNCTION DURING SCHEDULED OCCUPIED PERIODS.
- ④ FACTORY INSTALLED JUMPER. FOR IMMEDIATE EMERGENCY SHUTDOWN OF ALL HVAC OPERATION, REMOVE JUMPER AND CONNECT NORMALLY CLOSED (NC) CONTACT TO R AND Rt TERMINALS.
- ⑤ FOR 8403-058, CHANGE "SYSTEM TYPE", SET UP FUNCTION 1, FROM 5 (2 HEAT / 1 COOL HEAT PUMP) TO 6 (2 HEAT / 2 COOL CONVENTIONAL). FOR 8403-059, NO CHANGE.

**FIGURE 17**  
**1-STAGE A/C with OPTIONAL ELECTRIC HEAT**  
**WITH ECONWM\* STYLE ECONOMIZER**

*Low Voltage Wiring Diagram*

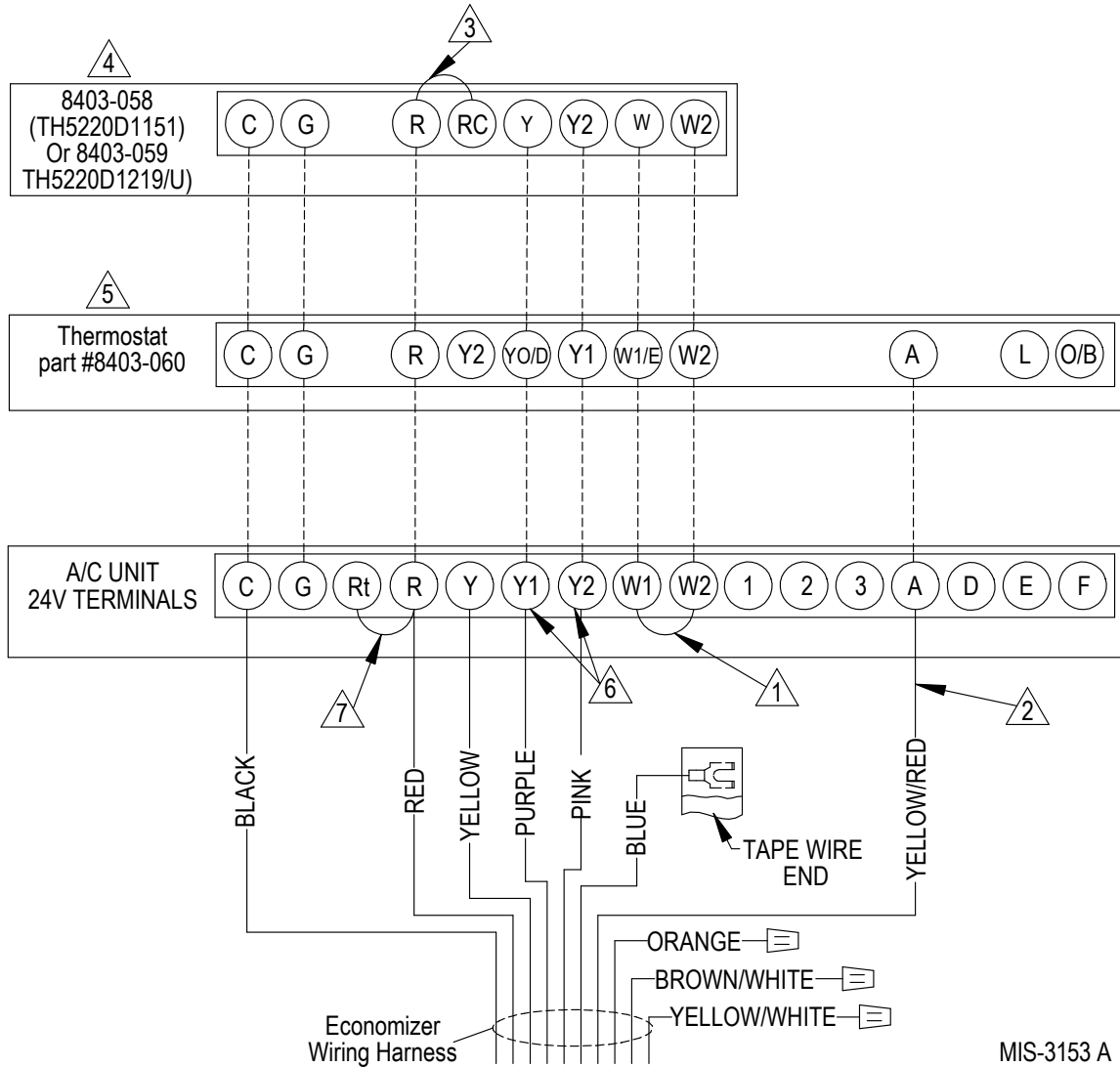

MIS-3153 A

- ⚠️ 1 Factory installed jumper. Remove for 2-stage operation on units with 15 or more kw.
- ⚠️ 2 Must be energized to enable minimum position. NOTE: Economizer Control Default Setting is 10V (100%). Depending upon application may require setting to lower value.
- ⚠️ 3 Factory Jumper Installed.
- ⚠️ 4 For 8403-058, Change "system type", set up function 1, from 5 (2 heat/ 1 cool heat pump) to 6 (2 heat/ 2 cool conventional). For 8403-059, No change.
- ⚠️ 5 Change model configuration from heat pump to heat/cool, and must be configured for economizer for YO/D output to be active as first stage cooling.
- ⚠️ 6 Older units may not have Y1 and Y2 connections on 24v terminal block. If not present wire nuts must be used.
- ⚠️ 7 Factory installed jumper. For immediate emergency shutdown of all HVAC operation, remove jumper and connect normally closed (NC) contact to R and Rt terminals.

**FIGURE 18**  
**2-STAGE A/C with OPTIONAL ELECTRIC HEAT**  
**WITH ECONWM\* STYLE ECONOMIZER**

*Low Voltage Wiring Diagram*

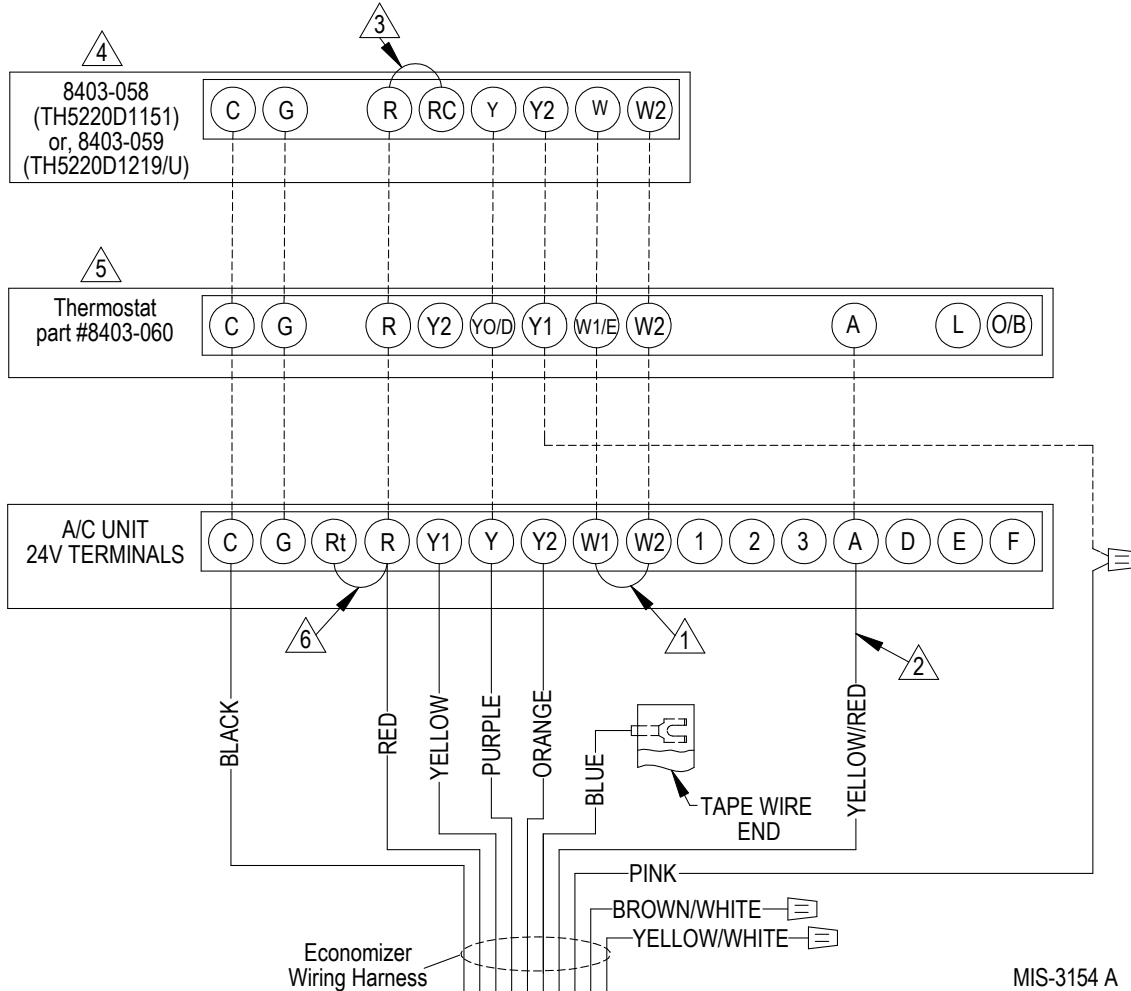

MIS-3154 A

- △1 Factory installed jumper. Remove for 2-stage operation on units with 15 or more kw.
- △2 Must be energized to enable minimum position. NOTE: Economizer Control Default Setting is 10V (100%). Depending upon application may require setting to lower value.
- △3 Factory Jumper Installed.
- △4 For 8403-058, Change "system type", set up function 1, from 5 (2 heat/ 1 cool heat pump) to 6 (2 heat/ 2 cool conventional). For 8403-059, No change
- △5 Change model configuration from heat pump to heat/cool, and must be configured for economizer for YO/D output to be active as first stage cooling.
- △6 Factory installed jumper. For immediate emergency shutdown of all HVAC operation, remove jumper and connect normally closed (NC) contact to R and Rt terminals.