



THE WALL-MOUNT™ STEP CAPACITY “QUIET CLIMATE” HEAT PUMPS Integrated Part Load Value (IPLV) Efficiency Up To 15.0 BTU/WATT

Models:	T30S to T60S	Up to 11.0 EER
Heating Capacities:		26,400 to 52,000 BTUH
Cooling Capacities:		22,400 to 56,000 BTUH

The Bard Wall-Mount Heat Pump is a self-contained energy efficient heating and cooling system, which is designed to offer maximum indoor comfort at a minimal cost without using valuable indoor floor space or outside ground space. This unit is the ideal product for versatile applications such as: new construction, modular offices, school modernization, telecommunication structures, portable structures or correctional facilities. Factory or field installed accessories are available to meet specific job requirements.

Engineered Features

Copper Tube / Aluminum Fin Coils:

Grooved copper tubing and enhanced aluminum fins provide maximum heat transfer and high energy efficiency. Standard evaporator coils use green fin stock for additional protection. Optional corrosion resistant coated coils are also available.

Twin Blowers:

Move air quietly. All models feature variable speed blower motors providing airflow adjustment for high and low static operation. Motor overload protection is standard on all models.

ECM Indoor Blower Motor:

Features a variable speed motor providing super-high efficiency, low sound levels and soft-start capabilities. The motor is self-adjusting to provide the proper airflow rate for the staged capacity, and for higher static pressure in ducted installations without user adjustment or wiring changes.

Heat Pump Compressor:

Scroll 2-Stage Compressors are standard on all 2½ to 5 ton models. Eliminates need for crankcase heater.

Double isolated floating compressor mounting system, compressor sound blanket, and discharge muffler for reduced outdoor sound level.

Phase Rotation Monitor:

Standard on all 3 phase scroll compressors. Protects against reverse rotation if power supply is not properly connected.

R-410A Refrigerant:

Designed with R-410A (HFC) non-ozone depleting refrigerant in compliance with the Montreal protocol and 2010 EPA requirements.

Liquid Line Filter Drier:

Standard on all units. Protects system against moisture.

Galvanized 20 Gauge Zinc Coated Steel Cabinet:

Cleaned, rinsed, sealed and dried before the polyurethane primer is applied. The cabinet is handsomely finished with a baked on, beige textured enamel, which allows it to withstand 1000 hours of salt spray tests per ASTM B117-03.

Stainless Steel cabinets available.

Foil Faced Insulation:

Standard on all units.

Electrical Components:

- Complies with efficiency requirements of ANSI/ASHRAE/IESNA 90.1-2019.
- Certified to ANSI/ARI Standard 390-2003 for SPVU (Single Package Vertical Units).
- Intertek ETL Listed to Standard for Safety Heating and Cooling Equipment ANSI/UL 1995/CSA 22.2 No. 236-05, Fourth Edition.
- Commercial Product - Not intended for Residential application.

Are easily accessible for routine inspection and maintenance through a right side, service panel opening. Features a lockable, hinged access cover to the circuit breaker or rotary disconnect switch.

Electric Heat Strips:

Features an automatic limit and thermal cut-off safety control. Heater packages are factory or field installed for all 2 through 5 ton models. Features easy slide-in field assembly with various BTUH outputs.

Condenser Fan and Motor Shroud Assembly:

Slide out for easy access.

Filter Service Door:

Separate service door provides easy access for filter change.

One Inch, Disposable Air Filters:

Are standard equipment. Optional one inch washable filters available and filter racks permit the addition of 2" pleated filter. Factory or field installed.

Solid State Electronic Heat Pump Control:

Provides efficient 30, 60 or 90 minute defrost cycle. A thermistor sensor, speed up terminal for service and 10 minute defrost override are standard on the electronic heat pump control.

High & Low Pressure Switches are Auto-Reset:

Standard on all units. Built-in lockout circuit resets from the room thermostat. Provides commercial quality protection to the compressor.

Five Minute Compressor Time Delay:

Short cycle protection is standard. Built into the heat pump control.

Emergency Heat Circuit:

Permits continuous operation of the system.

Barometric Fresh Air Damper:

Standard on all units. Allows up to 25% outside fresh air. Not installed if other optional vent packages selected.

Built-in Circuit Breakers:

Standard on all electric heat versions of single and three phase (230/208 volt) equipment. Rotary disconnects are standard

GREEN REFRIGERANT R-410A



on all electric heat versions of three phase (460 volt) equipment.

Slope Top:

Standard feature for water run-off.

Full Length Mounting Brackets:

Built into cabinet for improved appearance and easy installation. NOTE: Bottom mounting bracket included to assist in installation.

Top Rain Flashing:

Standard feature on all models.

Ventilation System Packages

Six ventilation options are available. See Page 3 for details on these options.



Globally Recognized. Industry Respected.



* The AHRI Certified® mark indicates Bard Manufacturing Company participation in the AHRI Certification program. For verification of individual certified products, go to www.ahridirectory.org.

Certified Capacity and Efficiency Ratings at Full Capacity

MODELS	T30S2	T36S1	T42S1	T48S1	T60S1
Cooling BTUH, Stage 2 (Full Capacity) ① 80/67-95	28,400	33,800	39,500	46,500	56,000
EER ①②	11.0	11.0	11.0	11.0	11.0
Rated CFM	900	1100	1250	1550	1650
IPLV (Integrated Stage 1 and Stage 2) ①③ 80/67-80	14.6	14.7	14.6	15.0	15.1
High Temp Heating (47F) BTUH, Stage 2 (Full Capacity)	26,600	33,000	39,000	43,000	52,000
COP ①④	3.30	3.40	3.30	3.50	3.30
Rated CFM	900	1100	1250	1550	1650
Low Temp Heating (17F) BTUH, Stage 2 (Full Capacity)	17,000	20,000	23,000	27,000	34,600
COP ④	2.30	2.40	2.20	2.30	2.40
Rated CFM	900	1100	1250	1550	1650

① Certified in accordance with ARI Standard 390-2003 for single package vertical units

② EER = Energy Efficiency Ratio - BTU/WATT efficiency

③ Integrated Part Load Value - BTU/WATT efficiency (combines Stage 1 & 2 performance)

④ COP = Coefficient of Performance - BTU/WATT efficiency

Capacity and Efficiency Ratings at Partial Capacity

MODELS	T30S2	T36S1	T42S1	T48S1	T60S1
Cooling BTUH, Stage 1 (Partial Capacity) 80/67-80	24,300	27,000	31,000	37,000	45,000
Operating CFM	650	800	900	1000	1300
High Temp. Heating 47°BTUH, Stage 1 (Partial Capacity)	19,000	22,600	26,000	30,800	38,000
Operating CFM	650	800	900	1000	1300

Specifications 2-1/2 through 3-Ton

MODELS	T30S2-A	T30S2-B	T30S2-C	T36S1-A	T36S1-B	T36S1-C
Electrical Rating – 60 Hz	230/208 - 1	230/208 - 3	460 - 3	230/208 - 1	230/208 - 3	460 - 3
Operating Voltage Range	197-253	197-253	414-506	197-253	197-253	414-506
Compressor--Circuit A						
Voltage	230/208	230/208	460	230/208	230/208	460
Rated Load Amps	9.6 / 10.8	7.1 / 8.0	4.0	11.5 / 12.9	8.8 / 9.8	4.9
Branch Circuit Selection Current	13.1	8.7	4.3	15.3	11.7	5.8
Lock Rotor Amps	73 / 73	58 / 58	28	83 / 83	73 / 73	38
Compressor Type	Scroll	Scroll	Scroll	Scroll	Scroll	Scroll
Fan Motor & Condenser						
Fan Motor--HP--RPM--SPD	1/3 - 1060 - 1	1/3 - 1060 - 1	1/3 - 1060 - 1	1/3 - 825 - 2	1/3 - 825 - 2	1/3 - 825 - 2
Fan Motor--Amps	1.5	1.5	1.5	2.5	2.5	1.1
Fan--DIA/CFM	20"-1900	20"-1900	20"-1900	24"-2900	24"-2900	24"-2900
Blower Motor & Evap.						
Blower Motor--HP-RPM-SPD	1/3 Var.	1/3 Var.	1/3 Var.	1/2 Var.	1/2 Var.	1/2 Var.
Blower Motor--Amps	2.8	2.8	2.8	3.2	3.2	3.2
CFM Cooling & E.S.P.	900 - .10	900 - .10	900 - .10	1100 - .15	1100 - .15	1100 - .15
w/Filter (Rated-Wet Coil)						
Filter Sizes (inches) STD.	16 x 30 x 1	16 x 30 x 1	16 x 30 x 1	20 x 30 x 1	20 x 30 x 1	20 x 30 x 1
Basic Unit Weight --LBS.						
	400	400	400	490	490	530
Barometric Fresh Air Damper	4	4	4	4.5	4.5	4.5
Blank-Off Plate	1	1	1	1	1	1
Motorized Fresh Air Damper	11	11	11	11.5	11.5	11.5
Commercial Room Ventilator	35	35	35	42	42	42
Economizer	64	64	64	50	50	50
Energy Recovery Ventilator	52	52	52	81	81	81

Specifications 3-1/2 through 5 Ton

MODELS	T42S1-A	T42S1-B	T42S1-C	T48S1-A	T48S1-B	T48S1-C	T60S1-A	T60S1-B	T60S1-C
Electrical Rating – 60 Hz	230/208 - 1	230/208 - 3	460 - 3	230/208 - 1	230/208 - 3	460 - 3	230/208 - 1	230/208 - 3	460 - 3
Operating Voltage Range	197-253	197-253	414-506	197-253	197-253	414-506	197-253	197-253	414-506
Compressor--Circuit A									
Voltage	230/208	230/208	460	230/208	230/208	460	230/208	230/208	460
Rated Load Amps	14.1 / 16	11.2 / 12.7	5.6	16.8 / 19.2	11.1 / 12.7	5.8	21.4 / 23.3	13.1 / 14.2	6.2
Branch Circuit Selection Current	18.0	14.2	6.3	21.2	14.1	6.5	27.2	16.6	7.3
Lock Rotor Amps	96 / 96	88 / 88	44	104	83 / 83	41	153 / 153	110 / 110	52
Compressor Type	Scroll	Scroll	Scroll	Scroll	Scroll	Scroll	Scroll	Scroll	Scroll
Fan Motor & Condenser									
Fan Motor--HP--RPM--SPD	1/3-825-2	1/3-825-2	1/3-825-1	1/3-825-2	1/3-825-2	1/3-825-1	1/2-1025-1	1/2-1025-1	1/2-1025-1
Fan Motor--Amps	2.5	2.5	1.2	2.5	2.5	1.2	3.8	3.8	3.8
Fan--DIA/CFM	24"-2900	24"-2900	24"-2900	24"-2900	24"-2900	24"-2900	24"-3700	24"-3700	24"-3700
Blower Motor & Evap.									
Blower Motor--HP-RPM-SPD	3/4 Var.	3/4 Var.	3/4 Var.	3/4 Var.	3/4 Var.	3/4 Var.	3/4 Var.	3/4 Var.	3/4 Var.
Blower Motor--Amps	4.0	4.0	4.0	4.9	4.9	4.9	4.9	4.9	4.9
CFM Cooling & E.S.P.	1250 - .15	1250 - .15	1250 - .15	1550 - .2	1550 - .2	1550 - .2	1650 - .2	1650 - .2	1650 - .2
w/Filter (Rated-Wet Coil)									
Filter Sizes (inches) STD.	20 x 30 x 1	20 x 30 x 1	20 x 30 x 1	20 x 30 x 1	20 x 30 x 1	20 x 30 x 1	20 x 30 x 1	20 x 30 x 1	20 x 30 x 1
Shipping Weight --LBS.									
	500	500	540	560	560	605	565	565	610
Barometric Fresh Air Damper	4.5	4.5	4.5	4.5	4.5	4.5	4.5	4.5	4.5
Blank-Off Plate	1	1	1	1	1	1	1	1	1
Motorized Fresh Air Damper	11.5	11.5	11.5	11.5	11.5	11.5	11.5	11.5	11.5
Commercial Room Ventilator	42	42	42	42	42	42	42	42	42
Economizer	50	50	50	50	50	50	50	50	50
Energy Recovery Ventilator	81	81	81	81	81	81	81	81	81

Ventilation System Packages

Bard Wall-Mounts are designed to provide optional ventilation packages to meet all of your ventilation and indoor air quality requirements. All units are equipped with a barometric fresh air damper as the standard ventilation package. All ventilation packages can be built-in at the factory, or field-installed at a later date.

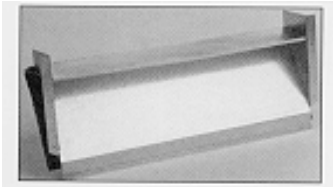

Barometric Fresh Air Damper

BAROMETRIC FRESH AIR DAMPER - BFAD

STANDARD

The barometric fresh air damper is a standard feature on all models. It is installed on the inside of the service door and allows outside ventilation air, up to 25% of the total airflow rating of the unit, to be introduced through the air inlet openings and to be mixed with the conditioned air. The damper opens during blower operation and closes when the blower is off. Adjustable blade stops allow different amounts of outside air to be introduced into the building and can be easily locked closed if required.

BLANK OFF PLATE - BOP

OPTIONAL

A blank off plate is installed on the inside of the service door. It covers the air inlet openings which restricts any outside air from entering into the unit. The blank off plate should be utilized in applications where outside air is not required to be mixed with the conditioned air.

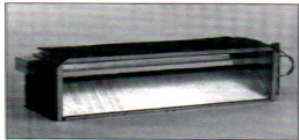

Motorized Fresh Air Damper

MOTORIZED FRESH AIR DAMPER - MFAD

OPTIONAL

The motorized fresh air damper is internally mounted behind the service door and allows outside ventilation air, up to 25% of the total airflow rating of the unit, to be introduced through the air inlet openings and to be mixed with the conditioned air. The two position damper can be fully open or closed. The damper blade is powered open by a 24VAC motor with spring return on power loss. The damper can be controlled by indoor blower operation or can be field connected to be managed based on building occupancy.

NOTE: The above vent systems are intake only without built-in exhaust capability. Building will likely require separate field installed barometric relief or mechanical exhaust elsewhere within the conditioned space. Balancing dampers in the return air grille may be required to achieve specified amount of outdoor air intake.



Commercial Room Ventilator

COMMERCIAL ROOM VENTILATOR - CRV

OPTIONAL

The built-in commercial room ventilator is internally mounted behind the service door and allows outside ventilation air, up to 50% of the total airflow rating of the unit, to be introduced through the air inlet openings. It includes a built-in exhaust air damper. A solid state board allows for simple on/off operation based on a 24VAC signal or full modulation with a 2-10VDC signal.

The commercial room ventilator (CRV) is a simple and innovative approach to improving the indoor air quality by providing fresh air intake and exhaust capability through the CRV. The damper can be easily adjusted to control the amount of fresh air supplied into the building. The CRV can be controlled by indoor blower operation or field controlled based on room occupancy. The CRV is power open - spring return on power loss. Complies with ANSI/ASHRAE Standard 62.1 "Ventilation for Acceptable Indoor Air Quality."

Models Available: CRVS - spring return on power loss or deactivation



Economizer

ECONOMIZER - ECONWM-Series

OPTIONAL

The built-in economizer system is internally mounted behind the service door and allows outdoor air to be introduced through the air inlet openings. The amount of outdoor air varies in response to the system controls and settings defined by the end user. It includes a built-in exhaust air damper. The economizer is designed to provide "free cooling" when outside air conditions are cool and dry enough to satisfy cooling requirements without running the compressor. This in turn provides lower operating costs, while extending the life of the compressor.

- ECONWMT Equipment Building versions have extended 11" air intake hood to deliver up to 100% of cooling rated airflow.
- ECONWMS Standard versions have 3" air intake hood to deliver up to 75% of cooling rated airflow. A relief damper may be necessary for this model when using the economizer.

Standard Features:

- Fully modulating
- Honeywell Direct Drive Hi-Torque Actuator
- No linkage required
- Simple single blade design
- Positive shut-off with non-stick gaskets
- Electronic DB and/or Enthalpy sensors depending upon version
- Honeywell JADE™ electronic economizer module with precision settings and diagnostics
- DB or Enthalpy economizer versions available



Energy Recovery Ventilator

WALL-MOUNT ENERGY RECOVERY VENTILATOR - ERV

OPTIONAL

The wall-mount energy recovery ventilator (ERV) is a highly innovative approach to meeting indoor air quality ventilation requirements as established by ANSI/ASHRAE Standard 62.1. The ERV allows from 200 to 450 CFM (depending upon model) of fresh air and exhaust through the unit while maintaining superior indoor comfort and humidity levels. In most cases this can be accomplished without increasing equipment sizing or operating costs. Heat transfer efficiency is up to 67% during summer and 75% during winter conditions.

The ERV consists of a unique "rotary energy recovery cassette" that provides effective sensible and latent heat transfer capabilities during summer and winter conditions. Various control schemes are addressed including limiting ventilation during building occupancy only.

The ERV is designed to be internally mounted behind the service door in the WA, WH or WL model wall-mount units. It can be built-in at the factory or field installed as an option. ERV-*3 and ERV-*5 can be independently adjusted for intake and exhaust rates. 3" air intake hood is standard.

T30 High Speed Total and Ventilation Airflow

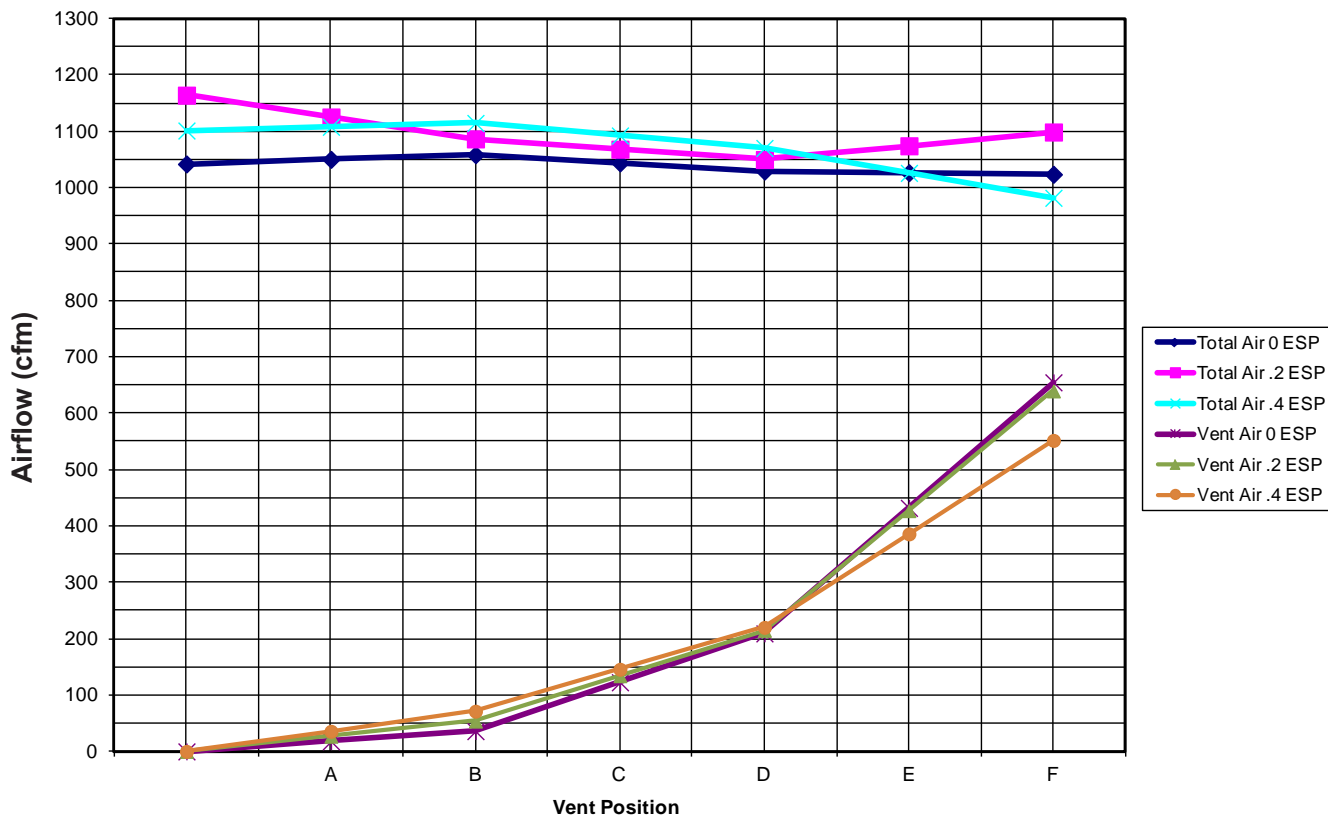

T24 High Speed Total and Ventilation Airflow
T30 Low Speed Total And Ventilation Airflow

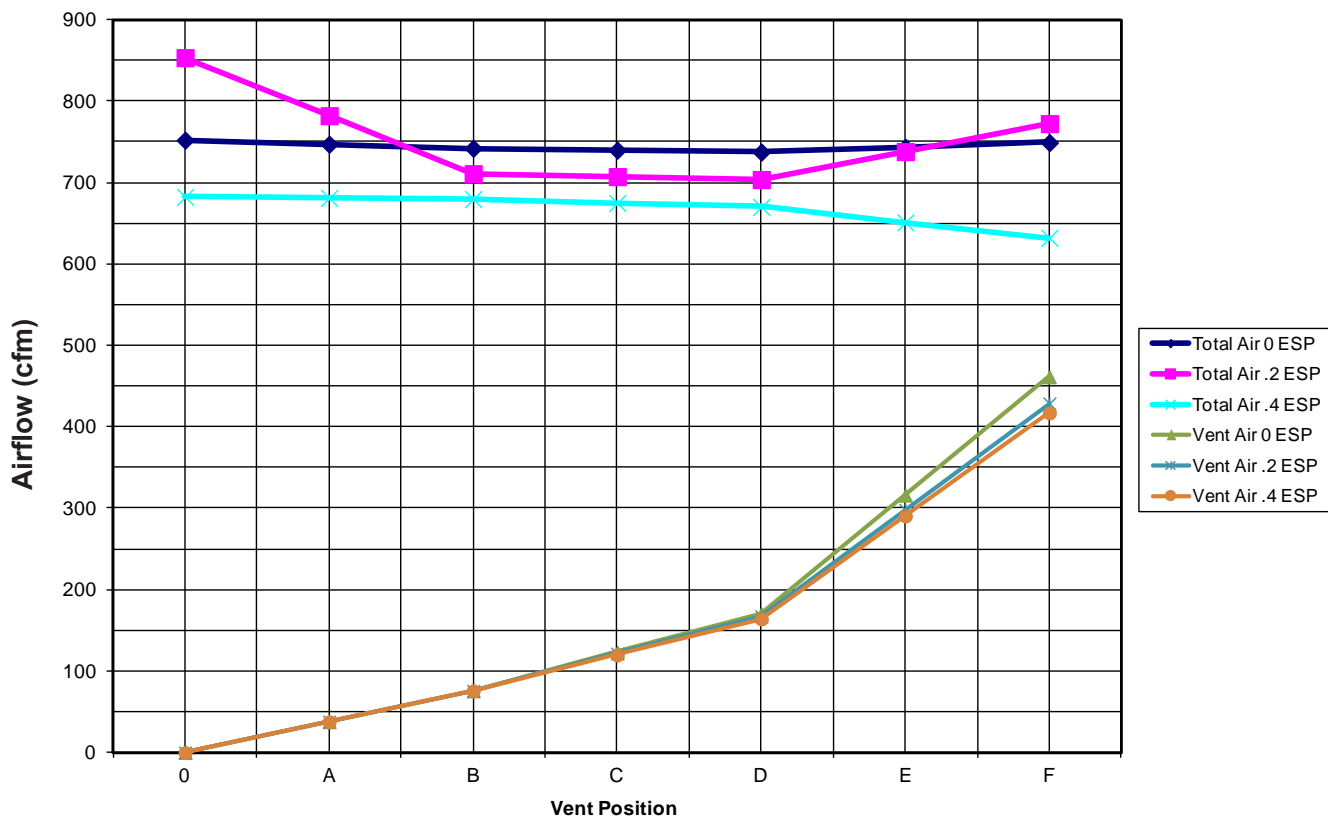

Commercial Room Ventilator Performance Data : CRVS-5A

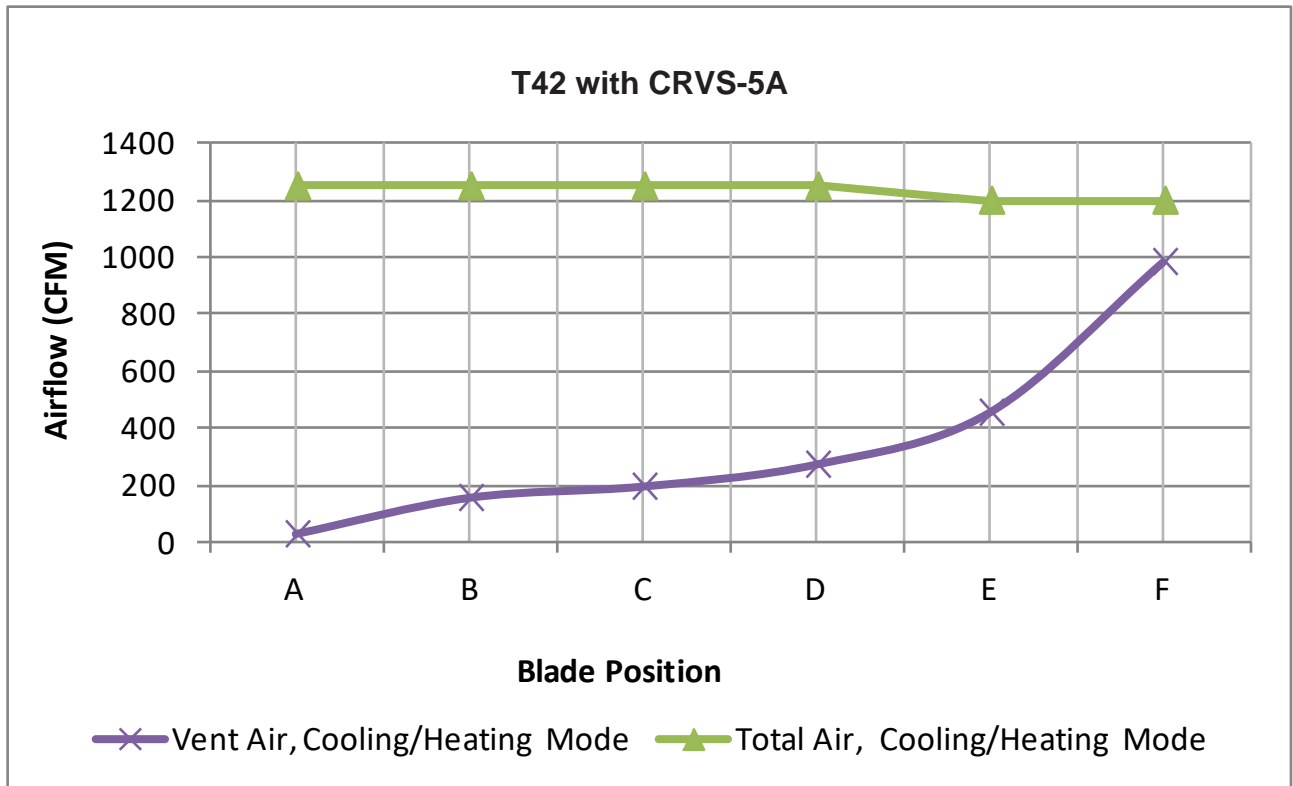
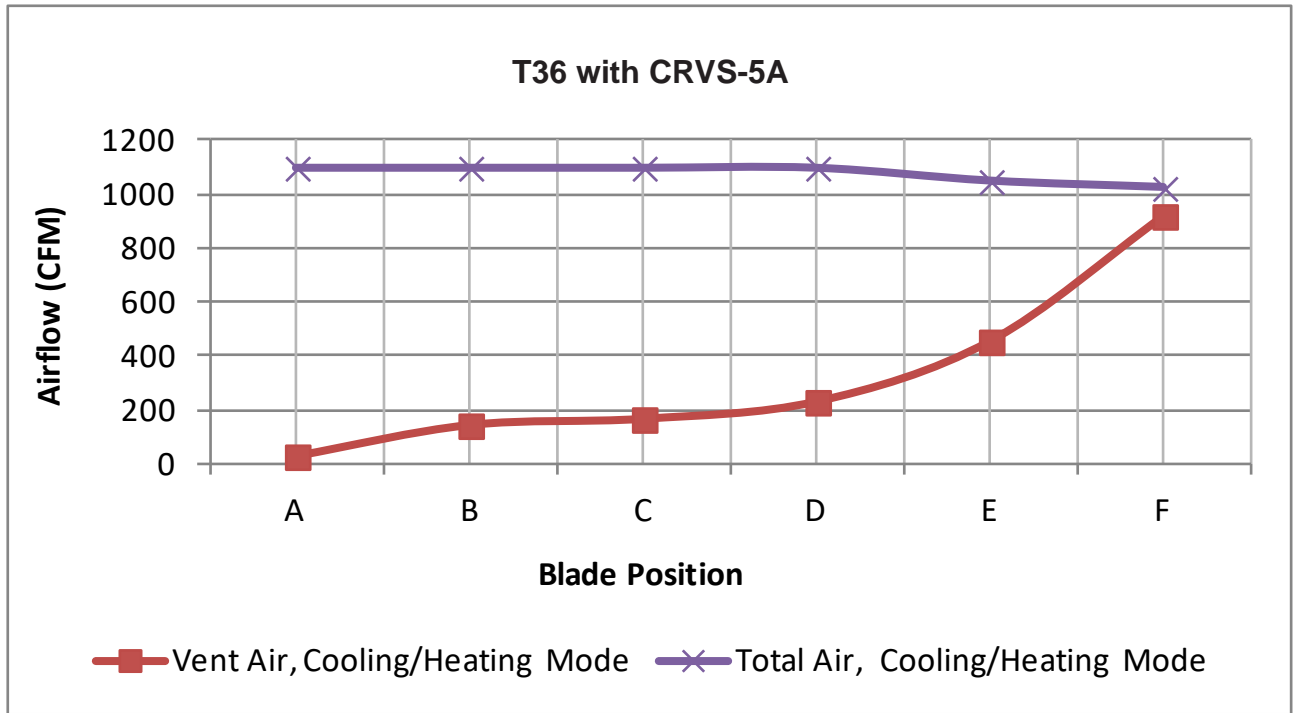

Commercial Room Ventilator Performance Data : CRVS-5A

T48 Vent Airflow

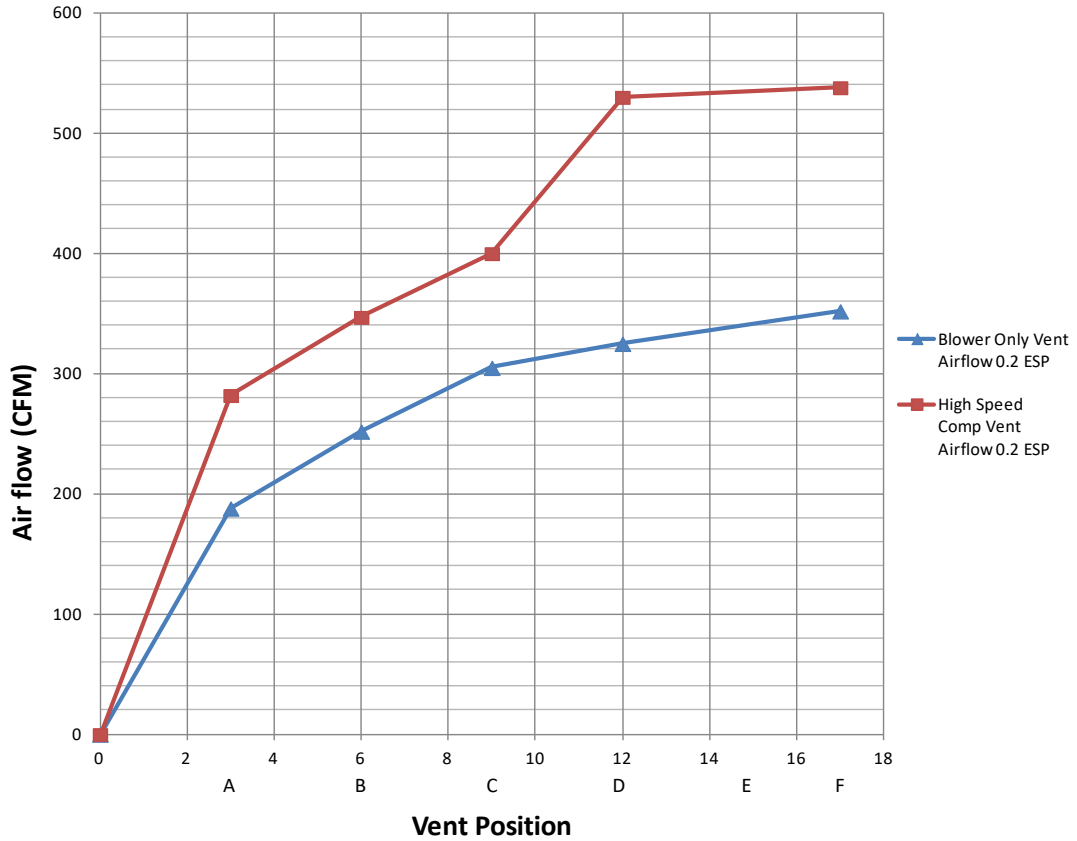

Commercial Room Ventilator Performance Data : CRVS-5A

T60 Vent Airflow

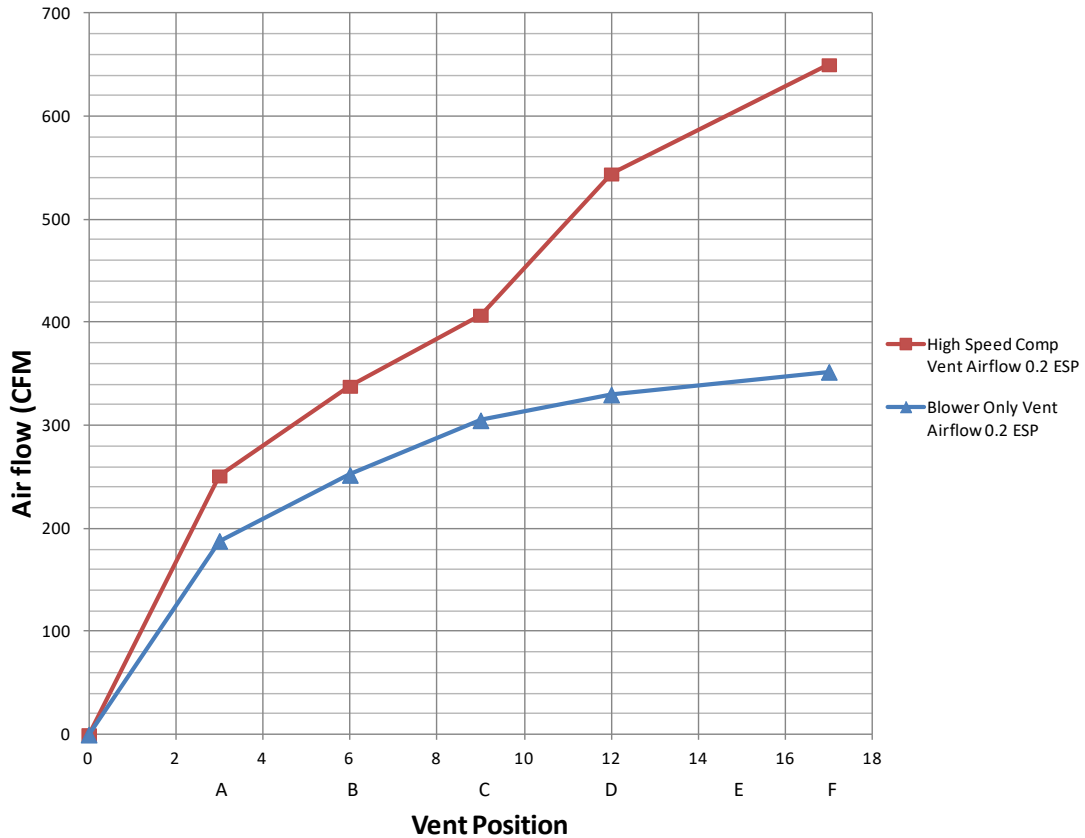

This Page Intentionally Left Blank

Performance and Application Data - ERVF- *3 (T30S2)

SUMMER COOLING PERFORMANCE (INDOOR DESIGN CONDITIONS 75°DB/62°WB)

Ambient O.D.	VENTILATION RATE -- 400 CFM 63% EFFICIENCY						VENTILATION RATE -- 325 CFM 64% EFFICIENCY						VENTILATION RATE -- 250 CFM 65% EFFICIENCY						
	DB/ WB	F	VLT	VLS	VLL	HRT	HRS	HRL	VLT	VLS	VLL	HRT	HRS	HRL	VLT	VLS	VLL	HRT	HRS
105	75	19080	12960	6120	12020	8164	3855	15502	10530	4972	9921	6739	3182	11925	8100	3825	7751	5265	2486
	70	12960	12960	0	8164	8164	0	10530	10530	0	6739	6739	0	8100	8100	0	5265	5265	0
	65	12960	12960	0	8164	8164	0	10530	10530	0	6739	6739	0	8100	8100	0	5265	5265	0
100	80	28080	10800	17280	17690	6804	10886	22815	8775	14040	14601	5616	8985	17550	6750	10800	11407	4387	7019
	75	19080	10800	8280	12020	6804	5216	15502	8775	6727	9921	5616	4305	11925	6750	5175	7751	4387	3363
	70	10980	10800	180	6717	6804	113	8921	8775	146	5709	5616	93	6862	6750	112	4460	4387	73
	65	10800	10800	0	6804	6804	0	8775	8775	0	5616	5616	0	6750	6750	0	4387	4387	0
	60	10800	10800	0	6804	6804	0	8775	8775	0	5616	5616	0	6750	6750	0	4387	4387	0
95	80	28080	8640	19440	17690	5443	12247	22815	7020	15795	14601	4492	10108	17550	5400	12150	11407	3510	7897
	75	19080	8640	10440	12020	5443	6577	15502	7020	8482	9921	4492	5428	11925	5400	6525	7751	3510	4241
	70	10980	8640	2340	6917	5443	1474	8921	7020	1901	5709	4492	1216	6862	5400	1462	4460	3510	950
	65	8640	8640	0	5443	5443	0	7020	7020	0	4492	4492	0	5400	5400	0	3510	3510	0
	60	8640	8640	0	5443	5443	0	7020	7020	0	4492	4492	0	5400	5400	0	3510	3510	0
90	80	28080	6480	21600	17690	4082	13608	22815	5265	17550	14601	3369	11232	17550	4050	13500	11407	2632	8774
	75	19080	6480	12600	12020	4082	7938	15502	5265	10237	9921	3369	6552	11925	4050	7875	7751	2632	5118
	70	10980	6480	4500	6917	4082	2835	8921	5265	3656	5709	3369	2340	6862	4050	2812	4460	2632	1828
	65	6480	6480	0	4082	4082	0	5265	5265	0	3369	3369	0	4050	4050	0	2632	2632	0
	60	6480	6480	0	4082	4082	0	5265	5265	0	3369	3369	0	4050	4050	0	2632	2632	0
85	80	28080	4320	23760	17690	2721	14968	22815	3510	19305	14601	2246	12355	17550	2700	14850	11407	1755	9652
	75	19080	4320	14760	12020	2721	9298	15502	3510	11992	9921	2246	7675	11925	2700	9225	7751	1755	5996
	70	10980	4320	6660	6917	2721	4195	8921	3510	5411	5709	2246	3463	6862	2700	4162	4460	1755	2705
	65	4320	4320	0	2721	2721	0	3510	3510	0	2246	2246	0	2700	2700	0	1755	1755	0
	60	4320	4320	0	2721	2721	0	3510	3510	0	2246	2246	0	2700	2700	0	1755	1755	0
80	75	19080	2160	16920	12020	1360	10659	15502	1755	13747	9921	1123	8798	11925	1350	10575	7751	877	6873
	70	10980	2160	8820	6917	1360	5556	8921	1755	7166	5709	1123	4586	6862	1350	5512	4460	877	3583
	65	3780	2160	1620	2381	1360	1020	3071	1755	1316	1965	1123	842	2362	1350	1012	1535	877	658
	60	2160	2160	0	1360	1360	0	1755	1755	0	1123	1123	0	1350	1350	0	877	877	0
75	70	10980	0	10980	6917	0	6917	8921	0	8921	5709	0	5709	6862	0	6862	4460	0	4460
	65	3780	0	3780	2381	0	2380	3071	0	3071	1965	0	1965	2362	0	2362	1535	0	1535
	60	0	0	0	0	0	0	0	0	0	0	0	0	0	0	0	0	0	0

ERVF- *3 WINTER HEATING PERFORMANCE (INDOOR DESIGN CONDITIONS 70°F DB)

Ambient O.D.	VENTILATION RATE					
	400 CFM 75% EFF.		325 CFM 76% EFF.		250 CFM 77% EFF.	
DB/°F	WVL	WHR	WVL	WHR	WVL	WHR
65	2160	1620	1755	1333	1350	1039
60	4320	3240	3510	2667	2700	2079
55	6480	4860	5265	4001	4050	3118
50	8640	6480	7020	5335	5400	4158
45	10800	8100	8775	6669	6750	5197
40	12960	9720	10530	8002	8100	6237
35	15120	11340	12285	9336	9450	7276
30	17280	12960	14040	10670	10800	8316
25	19440	14580	15795	12004	12150	9355
20	21600	16200	17550	13338	13500	10395
15	23760	17820	19305	14671	14850	11434

LEGEND:

VLT = Ventilation Load - Total
 VLS = Ventilation Load - Sensible
 VLL = Ventilation Load - Latent
 HRT = Heat Recovery - Total
 HRS = Heat Recovery - Sensible
 HRL = Heat Recovery - Latent
 WWL = Ventilation Load - Latent
 WHR = Heat Recovery - Total

NOTE: Sensible performance only is shown for winter application.

Performance and Application Data - ERVF-*5 (T36S1, T42S1, T48S1 & T60S1)

SUMMER COOLING PERFORMANCE (INDOOR DESIGN CONDITIONS 75°DB/62°WB)

Ambient O.D.		VENTILATION RATE -- 450 CFM						VENTILATION RATE -- 375 CFM						VENTILATION RATE -- 300 CFM					
DB/WB	F	VLT	VLS	VLL	HRT	HRS	HRL	VLT	VLS	VLL	HRT	HRS	HRL	VLT	VLS	VLL	HRT	HRS	HRL
105	75	21465	14580	6884	13952	9477	4475	17887	12150	5737	11805	8018	3786	14310	9720	4590	9587	6512	3075
	70	14580	14580	0	9477	9477	0	12150	12150	0	8018	8018	0	9720	9720	0	6512	6512	0
	65	14580	14580	0	9477	9477	0	12150	12150	0	8018	8018	0	9720	9720	0	6512	6512	0
100	80	31590	12150	19440	20533	7897	12635	26325	10125	16200	17374	6682	10692	21060	8100	12960	14110	5427	8683
	75	21465	12150	9314	13952	7897	6054	17887	10125	7762	11805	6682	5123	14310	8100	6210	9587	5427	4160
	70	12352	12150	202	8029	7897	131	10293	10125	168	6793	6682	111	8235	8100	135	5517	5427	90
	65	12150	12150	0	7897	7897	0	10125	10125	0	6682	6682	0	8100	8100	0	5427	5427	0
	60	12150	12150	0	7897	7897	0	10125	10125	0	6682	6682	0	8100	8100	0	5427	5427	0
95	80	31590	9720	21870	20533	6318	14215	26325	8100	18225	17374	5345	12028	21060	6480	14580	14110	4341	9768
	75	21465	9720	11744	13952	6318	7634	17887	8100	9787	11805	5345	6459	14310	6480	7830	9587	4341	5246
	70	12352	9720	2632	8029	6318	1711	10293	8100	2193	6793	5345	1447	8235	6480	1755	5517	4341	1175
	65	9720	9720	0	6318	6318	0	8100	8100	0	5345	5345	0	6480	6480	0	4341	4341	0
	60	9720	9720	0	6318	6318	0	8100	8100	0	5345	5345	0	6480	6480	0	4341	4341	0
90	80	31590	7290	24300	20533	4738	15794	26325	6075	20250	17374	4009	13365	21060	4860	16200	14110	3256	10854
	75	21465	7290	14175	13952	4738	9213	17887	6075	11812	11805	4009	7796	14310	4860	9450	9587	3256	6331
	70	12352	7290	5062	8029	4738	3290	10293	6075	4218	6793	4009	2784	8235	4860	3375	5517	3256	2261
	65	7290	7290	0	4738	4738	0	6075	6075	0	4009	4009	0	4860	4860	0	3256	3256	0
	60	7290	7290	0	4738	4738	0	6075	6075	0	4009	4009	0	4860	4860	0	3256	3256	0
85	80	31590	4860	26730	20533	3159	17374	26325	4050	22275	17374	2672	14701	21060	3240	17820	14110	2170	11939
	75	21465	4860	16605	13952	3159	10793	17887	4050	13837	11805	2672	9132	14310	3240	11070	9587	2170	7416
	70	12352	4860	7492	8029	3159	4870	10293	4050	6243	6793	2672	4120	8235	3240	4995	5517	2170	3346
	65	4860	4860	0	3159	3159	0	4050	4050	0	2672	2672	0	3240	3240	0	2170	2170	0
	60	4860	4860	0	3159	3159	0	4050	4050	0	2672	2672	0	3240	3240	0	2170	2170	0
80	75	21465	2430	19035	13952	13952	12372	17887	2025	15862	11805	1336	10469	14310	1620	12690	9587	1085	8502
	70	12352	2430	9922	8029	8029	6449	10293	2025	8268	6793	1336	5457	8235	1620	6615	5517	1085	4432
	65	4252	2430	1822	2764	2764	1184	3543	2025	1518	2338	1336	1002	2835	1620	1215	1899	1085	814
	60	2430	2430	0	1579	1579	0	2025	2025	0	1336	1336	0	1620	1620	0	1085	1085	0
75	70	12352	0	12352	8029	0	8029	10293	0	10293	6793	0	6793	8235	0	8235	5517	0	5517
	65	4252	0	4252	2764	0	2764	3543	0	3543	2338	0	2338	2835	0	2835	1899	0	1899
	60	0	0	0	0	0	0	0	0	0	0	0	0	0	0	0	0	0	0

ERVF-*5 WINTER HEATING PERFORMANCE (INDOOR DESIGN CONDITIONS 70°F DB)

Ambient O.D.	VENTILATION RATE					
	450 CFM		375 CFM		300 CFM	
	WVL	WHR	WVL	WHR	WVL	WHR
65	2430	1944	2025	1640	1620	1328
60	4860	3888	4050	3280	3240	2656
55	7290	5832	6075	4920	4860	3985
50	9720	7776	8100	6561	6480	5313
45	12150	9720	10125	8201	8100	6642
40	14580	11664	12150	9841	9720	7970
35	17010	13608	14175	11481	11340	9298
30	19440	15552	16200	13122	12960	10627
25	21870	17496	18225	14762	14580	11955
20	24300	19440	20250	16402	16200	13284
15	26730	21384	22275	18042	17820	14612

LEGEND:

- VLT = Ventilation Load - Total
- VLS = Ventilation Load - Sensible
- VLL = Ventilation Load - Latent
- HRT = Heat Recovery - Total
- HRS = Heat Recovery - Sensible
- HRL = Heat Recovery - Latent
- WVL = Ventilation Load - Latent
- WHR = Heat Recovery - Total

NOTE: Sensible performance only is shown for winter application.

Electrical Specifications — Standard Heat Pumps

MODEL	Rated Volts & Phase	No. Field Power Circuits	Single Circuit				Multiple Circuit													
			① Minimum Circuit Ampacity	② Maximum External Fuse or Ckt. Brkr.	③ Field Power Wire Size	④ Ground Wire	① Minimum Circuit Ampacity			② Maximum External Fuse or Ckt. Breaker			③ Field Power Wire Size			④ Ground Wire Size				
							Ckt. A	Ckt. B	Ckt. C	Ckt. A	Ckt. B	Ckt. C	Ckt. A	Ckt. B	Ckt. C	Ckt. A	Ckt. B	Ckt. C		
T30S2-A00, A0Z -A04 Ⓞ -AS8 Ⓞ -AF8	230/208-1	1 1 1 1 or 2	23 44 49 65	35 50 50 70	8 8 8 6	10 10 10 8			24	42			35	45		8	8		10	10
T30S2-B00, B0Z -B06 -B09	230/208-3	1 1 1	18 36 45	25 40 45	10 8 8	10 10 10														
T30S2-C0Z -C06 -C09	460-3	1 1 1	10 19 24	15 20 25	14 12 10	14 12 10														
T36S1-A00, A0Z -A05 -A08 -A10 Ⓞ -A15	230/208-1	1 1 1 or 2 1 or 2 1 or 2	27 53 69 79 85	40 60 70 80 90	8 6 4 4 4	10 10 8 8 8			27 42 27 33	42 52 52 52			40 45 40 40	45 60 60 60		8 8 8 8	8 6 6 6		10 10 10 10	10 10 10 10
T36S1-B00, B0Z -B06 -B09 Ⓞ -B15	230/208-3	1 1 1 1	23 41 50 52	30 45 50 60	10 8 6 6	10 10 10 10														
T36S1-C0Z -C06 -C09 Ⓞ -C15	460-3	1 1 1 1	12 21 26 27	15 25 30 30	14 10 10 10	14 10 10 10														
T42S1-A00, A0Z -A05 -A08 -A10 Ⓞ -A15	230/208-1	1 1 1 or 2 1 or 2 1 or 2	31 57 73 83 86	40 60 80 90 90	8 6 4 4 3	10 10 8 8 8			31 42 31 34	42 52 52 52			40 45 40 40	45 60 60 60		8 8 8 8	8 6 6 6		10 10 10 10	10 10 10 10
T42S1-B00, B0Z -B06 -B09 Ⓞ -B15	230/208-3	1 1 1 1	26 44 53 53	35 50 60 60	8 8 6 6	10 10 10 10														
T42S1-C0Z -C06 -C09 Ⓞ -C15	460-3	1 1 1 1	13 22 27 27	15 25 30 30	14 10 10 10	14 10 10 10														
T48S1-A00, A0Z -A04 -A05 -A08 -A10 Ⓞ -A15	230/208-1	1 1 1 or 2 1 or 2 1 or 2 1 or 2	37 57 63 78 89 89	50 60 70 90 100 100	8 6 6 4 3 3	10 10 8 8 8 8			37 42 37 37 37	26 52 42 52 52			50 50 50 50 50	30 60 60 60 60		8 8 8 8 8	10 8 6 6 6		10 10 10 10 10	10 10 10 10 10
T48S1-B00, B0Z -B06 -B09 Ⓞ -B15	230/208-3	1 1 1 1	28 46 55 55	40 50 60 60	8 8 6 6	10 10 10 10														
T48S1-C0Z -C06 -C09 Ⓞ -C15	460-3	1 1 1 1	14 23 28 29	20 25 30 30	12 10 10 10	12 10 10 10														
T60S1-A00, A0Z -A05 -A10 Ⓞ -A15 Ⓞ -A20	230/208-1	1 1 or 2 1 or 2 1 or 2 1 or 3	45 71 97 97 113	60 80 100 100 125	8 4 3 3 2	10 8 8 8 6			45 45 45 45	26 52 52 52			50 50 50 50	30 60 60 60		8 8 8 8	10 6 6 6	10	10 10 10 10	10 10 10 10
T60S1-B00, B0Z -B09 Ⓞ -B15 Ⓞ -B18	230/208-3	1 1 1 2	32 59 59 N/A	45 60 60 N/A	8 6 6 N/A	10 10 10 N/A			59	28			60	30		6	10		10	10
T60S1-C0Z -C09 Ⓞ -C15 Ⓞ -C18	460-3	1 1 1 1	15 29 30 34	20 30 30 35	12 10 10 8	12 10 10 10														

- ① These “Minimum Circuit Ampacity” values are to be used for sizing the field power conductors. Refer to the National Electrical Code (latest version), Article 310 for power conductor sizing.
- Caution:** When more than one field power circuit is run through one conduit, the conductors must be derated. Pay special attention to note 8 of Table 310 regarding Ampacity Adjustment Factors when more than three (3) conductors are in a raceway.
- ② Maximum size of the time delay fuse or circuit breaker for protection of field wiring conductors.
- ③ Based on 75°C copper wire. All wiring must conform to the National Electrical Code and all local codes.
- ④ Maximum KW that can operate with the heat pump on is 4KW. Full heat available during Emergency Heat Mode.
- ⑤ Maximum KW that can operate with the heat pump on is 10KW. Full heat available during Emergency Heat Mode.
- ⑥ Maximum KW that can operate with the heat pump on is 9KW. Full heat available during Emergency Heat Mode.
- ⑦ Maximum KW that can operate with the heat pump on is 8KW. Full heat available during Emergency Heat Mode.

IMPORTANT: While this electrical data is presented as a guide, it is important to electrically connect properly sized fuses & conductor wires in accordance with the National Electrical Code & all local codes.

Electrical Specifications — Dehumidification Models

MODEL	Rated Volts & Phase	No. Field Power Circuits	Single Circuit				Multiple Circuit													
			① Minimum Circuit Ampacity	② Maximum External Fuse or Ckt. Brkr.	③ Field Power Wire Size	④ Ground Wire	① Minimum Circuit Ampacity			② Maximum External Fuse or Ckt. Breaker			③ Field Power Wire Size			④ Ground Wire Size				
							Ckt. A	Ckt. B	Ckt. C	Ckt. A	Ckt. B	Ckt. C	Ckt. A	Ckt. B	Ckt. C	Ckt. A	Ckt. B	Ckt. C		
T30S2DA00, AOZ DA04 ④ DAS8 ⑦ DAF8	230/208-1	1	23	35	8	10														
		1	44	50	8	10														
		1	49	50	8	10														
		1 or 2	65	70	6	8	24	42		35	45		8	8		10	10			
T30S2DB00, BOZ DB06 DB09	230/208-3	1	18	25	10	10														
		1	36	40	8	10														
		1	45	45	8	10														
T30S2DC0Z DC06 DC09	460-3	1	10	15	14	14														
		1	19	20	12	12														
		1	24	25	10	10														
T36S1DA00, AOZ DA05 DA08 DA10 ⑤ DA15	230/208-1	1	29	40	8	10														
		1	55	60	6	10														
		1 or 2	70	70	4	8	27	42		40	45		8	8		10	10			
		1 or 2	80	80	4	8	27	52		40	60		8	6		10	10			
		1 or 2	85	90	4	8	33	52		40	60		8	6		10	10			
T36S1DB00, BOZ DB06 DB09 ⑥ DB15	230/208-3	1	24	30	10	10														
		1	42	45	8	10														
		1	50	50	6	10														
		1	52	60	6	10														
		1	52	60	6	10														
T36S1DC0Z DC06 DC09 ⑥ DC15	460-3	1	14	15	14	14														
		1	23	25	10	10														
		1	28	30	10	10														
		1	28	30	10	10														
		1	29	30	10	10														
T42S1DA00, AOZ DA05 DA08 DA10 ⑤ DA15	230/208-1	1	31	40	8	10														
		1	57	60	6	10														
		1 or 2	73	80	4	8	31	42		40	45		8	8		10	10			
		1 or 2	83	90	4	8	31	52		40	60		8	6		10	10			
		1 or 2	86	90	3	8	34	52		40	60		8	6		10	10			
T42S1DB00, BOZ DB06 DB09 ⑥ DB15	230/208-3	1	26	35	8	10														
		1	44	50	8	10														
		1	53	60	6	10														
		1	53	60	6	10														
		1	53	60	6	10														
T42S1DC0Z DC06 DC09 ⑥ DC15	460-3	1	13	15	14	14														
		1	22	25	10	10														
		1	27	30	10	10														
		1	27	30	10	10														
		1	27	30	10	10														
T48S1DA00, AOZ DA04 DA05 DA08 DA10 ⑤ DA15	230/208-1	1	37	50	8	10														
		1	57	60	6	10														
		1 or 2	63	70	6	8	37	26		50	30		8	10		10	10			
		1 or 2	78	90	4	8	37	42		50	50		8	8		10	10			
		1 or 2	89	100	3	8	37	52		50	60		8	6		10	10			
		1 or 2	89	100	3	8	37	52		50	60		8	6		10	10			
T48S1DB00, BOZ DB06 DB09 ⑥ DB15	230/208-3	1	28	40	8	10														
		1	46	50	8	10														
		1	55	60	6	10														
		1	55	60	6	10														
		1	55	60	6	10														
T48S1DC0Z DC06 DC09 ⑥ DC15	460-3	1	14	20	12	12														
		1	23	25	10	10														
		1	28	30	10	10														
		1	28	30	10	10														
		1	29	30	10	10														
T60S1DA00, AOZ DA05 DA10 ⑤ DA15 ⑤ DA20	230/208-1	1	45	60	8	10														
		1 or 2	71	80	4	8	45	26		50	30		8	10		10	10			
		1 or 2	97	100	3	8	45	52		50	60		8	6		10	10			
		1 or 2	97	100	3	8	45	52		50	60		8	6		10	10			
		1 or 2	97	100	3	8	45	52		50	60		8	6		10	10			
		1 or 3	113	125	2	6	45	52	26	50	60	30	8	6	10	10	10	10		
T60S1DB00, BOZ DB09 ⑥ DB15 ⑥ DB18	230/208-3	1	32	45	8	10														
		1	59	60	6	10														
		1	59	60	6	10														
		2	N/A	N/A	N/A	N/A	59	28		60	30		6	10		10	10			
		1	N/A	N/A	N/A	N/A	59	28		60	30		6	10		10	10			
T60S1DC0Z DC09 ⑥ DC15 ⑥ DC18	460-3	1	15	20	12	12														
		1	29	30	10	10														
		1	30	30	10	10														
		1	30	30	10	10														
		1	34	35	8	10														

① These “Minimum Circuit Ampacity” values are to be used for sizing the field power conductors. Refer to the National Electrical Code (latest version), Article 310 for power conductor sizing.

Caution: When more than one field power circuit is run through one conduit, the conductors must be derated. Pay special attention to note 8 of Table 310 regarding Ampacity Adjustment Factors when more than three (3) conductors are in a raceway.

② Maximum size of the time delay fuse or circuit breaker for protection of field wiring conductors.

③ Based on 75°C copper wire. All wiring must conform to the National Electrical Code and all local codes.

④ Maximum KW that can operate with the heat pump on is 4KW. Full heat available during Emergency Heat Mode.

⑤ Maximum KW that can operate with the heat pump on is 10KW. Full heat available during Emergency Heat Mode.

⑥ Maximum KW that can operate with the heat pump on is 9KW. Full heat available during Emergency Heat Mode.

⑦ Maximum KW that can operate with the heat pump on is 8KW. Full heat available during Emergency Heat Mode.

IMPORTANT: While this electrical data is presented as a guide, it is important to electrically connect properly sized fuses & conductor wires in accordance with the National Electrical Code & all local codes.

Full Load Cooling Application Data - Outdoor Temperature °F ①

Model	Return Air (DB/WB) ②	Cooling Capacity	75°F	80°F	85°F	90°F	95°F	100°F	105°F	110°F	115°F	120°F	125°F	131°F
T30S2	75/62	Total Cooling	32,500	30,300	28,300	26,500	24,800	23,500	22,300	21,300	20,600	19,900	19,400	19,000
		Sensible Cooling	24,700	23,400	22,300	21,300	20,500	19,800	19,200	18,800	18,400	18,200	17,700	16,800
	80/67	Total Cooling	34,700	33,000	31,400	29,900	28,400	27,400	26,300	25,400	24,700	24,100	23,600	23,200
		Sensible Cooling	23,900	22,900	22,100	21,300	20,700	20,100	19,700	19,400	19,100	19,000	19,000	19,100
T36S1	75/62	Total Cooling	41,400	38,600	36,100	33,800	31,700	30,000	28,400	27,100	26,000	25,100	24,300	23,600
		Sensible Cooling	24,500	23,300	22,200	21,200	20,300	19,500	18,800	18,200	17,600	17,200	16,800	16,500
	80/67	Total Cooling	36,700	34,600	32,700	30,900	29,300	27,800	26,600	25,300	24,200	23,300	N/A	N/A
		Sensible Cooling	28,700	28,100	27,400	26,600	26,000	25,300	24,500	23,700	23,000	22,200	N/A	N/A
T42S1	75/62	Total Cooling	39,200	37,700	36,300	34,900	33,800	32,400	31,300	30,200	29,100	28,200	N/A	N/A
		Sensible Cooling	27,800	27,500	27,100	26,600	26,200	25,700	25,100	24,500	23,900	23,200	N/A	N/A
	85/72	Total Cooling	46,700	44,100	41,700	39,400	37,300	35,500	33,800	32,200	30,600	29,300	N/A	N/A
		Sensible Cooling	28,500	27,900	27,300	26,400	25,700	24,900	23,900	23,000	22,000	21,000	N/A	N/A
T48S1	75/62	Total Cooling	42,100	40,100	38,300	36,500	34,700	33,000	31,300	29,700	28,100	26,500	N/A	N/A
		Sensible Cooling	33,400	32,400	31,300	30,400	29,500	28,600	27,800	27,100	26,400	25,700	N/A	N/A
	80/67	Total Cooling	44,900	43,700	42,500	41,200	39,500	38,400	36,900	35,400	33,800	32,100	N/A	N/A
		Sensible Cooling	32,400	31,700	31,000	30,400	29,700	29,100	28,500	28,000	27,400	26,900	N/A	N/A
T60S1	75/62	Total Cooling	53,500	51,100	48,800	46,500	44,200	42,000	39,800	37,700	35,500	33,400	N/A	N/A
		Sensible Cooling	33,200	32,200	31,200	30,200	29,200	28,200	27,200	26,300	25,300	24,300	N/A	N/A
	85/72	Total Cooling	48,800	46,600	44,600	42,500	40,500	38,600	36,800	35,000	33,200	31,400	N/A	N/A
		Sensible Cooling	39,400	38,500	37,600	36,700	35,700	34,800	33,800	32,800	31,800	30,800	N/A	N/A
T30S2	80/67	Total Cooling	52,100	50,800	49,500	48,000	46,500	45,000	43,400	41,700	39,900	38,000	N/A	N/A
		Sensible Cooling	38,200	37,700	37,200	36,700	36,000	35,400	34,700	33,900	33,100	32,200	N/A	N/A
	85/72	Total Cooling	62,100	59,400	56,900	54,200	51,700	49,200	46,800	44,400	41,900	39,500	N/A	N/A
		Sensible Cooling	39,100	38,300	37,400	36,500	35,300	34,300	33,100	31,800	30,500	29,100	N/A	N/A
T36S1	75/62	Total Cooling	58,100	55,600	53,200	51,000	48,800	46,700	44,700	42,700	40,800	38,900	N/A	N/A
		Sensible Cooling	45,200	43,700	42,400	41,100	39,900	38,800	37,800	36,900	36,000	35,200	N/A	N/A
	80/67	Total Cooling	62,000	60,600	59,100	57,600	56,000	54,400	52,700	50,900	49,100	47,200	N/A	N/A
		Sensible Cooling	43,800	42,800	42,000	41,100	40,300	39,500	38,800	38,100	37,400	36,800	N/A	N/A
T42S1	75/62	Total Cooling	73,900	70,900	67,900	65,000	62,200	59,500	56,800	54,200	51,600	49,100	N/A	N/A
		Sensible Cooling	44,900	43,400	42,200	40,800	39,500	38,200	37,000	35,700	34,500	33,300	N/A	N/A
	85/72	Total Cooling	44,900	43,400	42,200	40,800	39,500	38,200	37,000	35,700	34,500	33,300	N/A	N/A

① Below 65°F, unit requires a factory or field installed low ambient control.

② Return air temperature °F.

Capacity Multiplier Factors			
% of Rated Airflow	-10	Rated	+10
Total BTUH	0.975	1.0	1.02
Sensible BTUH	0.975	1.0	1.05

Full Load Heating Application Rating & Outdoor Temperature °F*

MODEL		0°	5°	10°	15°	20°	25°	30°	35°	40°	45°	50°	55°	60°F
T30S2	BTUH	10,300	12,200	14,000	15,900	17,300	18,300	19,400	20,500	23,500	26,600	29,000	30,800	32,700
	WATTS	2090	2120	2160	2200	2210	2220	2220	2230	2310	2400	2460	2490	2530
	COP	1.45	1.69	1.90	2.12	2.30	2.42	2.57	2.70	2.99	3.25	3.46	3.63	3.79
T36S1	BTUH	14,200	16,200	18,200	20,200	21,600	22,400	23,200	24,100	27,800	31,600	34,200	36,200	38,200
	WATTS	2300	2340	2390	2430	2460	2480	2500	2520	2600	2670	2730	2780	2820
	COP	1.81	2.03	2.24	2.44	2.58	2.65	2.72	2.81	3.14	3.47	3.68	3.82	3.97
T42S1	BTUH	14,000	16,600	19,300	22,000	23,900	25,400	26,900	28,400	32,800	37,300	40,600	43,300	46,000
	WATTS	2750	2810	2870	2930	2960	2970	2980	2990	3130	3270	3370	3430	3490
	COP	1.50	1.74	1.98	2.20	2.37	2.51	2.65	2.79	3.08	3.35	3.53	3.70	3.87
T48S1	BTUH	18,000	20,600	23,300	26,000	28,000	29,500	31,100	32,700	37,000	41,300	44,600	47,300	50,000
	WATTS	3010	3070	3130	3190	3240	3280	3320	3360	3450	3540	3610	3670	3730
	COP	1.76	1.97	2.19	2.39	2.54	2.64	2.75	2.86	3.15	3.42	3.62	3.78	3.93
T60S1	BTUH	24,800	27,700	30,600	33,500	35,800	37,600	39,400	41,300	45,800	50,300	53,800	56,700	59,600
	WATTS	3770	3850	3930	4010	4080	4140	4200	4260	4370	4470	4560	4640	4720
	COP	1.93	2.11	2.29	2.45	2.58	2.67	2.75	2.85	3.08	3.30	3.46	3.59	3.70

* 70°F DB indoor return air at rated CFM includes defrost operation below 45°.

Part Load Cooling Application Data - Outdoor Temperature °F ①

Model	Return Air (DB/WB) ②	Cooling Capacity	75°F	80°F	85°F	90°F	95°F	100°F	105°F	110°F	115°F	120°F	125°F	131°F
T30S2	75/62	Total Cooling Sensible Cooling	23,500 18,100	22,300 17,600	21,300 17,100	20,200 16,600	19,200 16,200	18,300 15,900	17,400 15,400	16,500 15,100	15,700 14,800	14,900 13,200	14,200 11,900	13,200 10,400
	80/67	Total Cooling Sensible Cooling	25,100 17,500	24,300 17,200	23,600 16,900	22,800 16,600	22,000 16,300	21,300 16,100	20,500 15,800	19,700 15,600	18,800 15,400	18,000 15,200	17,200 15,000	16,100 12,700
	85/72	Total Cooling Sensible Cooling	29,900 18,000	28,400 17,500	27,100 17,000	25,800 16,500	24,500 16,000	23,300 15,600	22,100 15,100	21,000 14,700	19,800 14,200	18,700 13,800	17,700 13,300	16,400 11,000
T36S1	75/62	Total Cooling Sensible Cooling	26,400 21,300	24,800 20,800	23,400 20,300	22,100 19,800	20,800 19,400	19,600 18,700	18,300 18,200	17,200 17,400	16,200 16,800	15,000 16,100	N/A	N/A
	80/67	Total Cooling Sensible Cooling	28,100 20,600	27,000 20,400	26,000 20,100	24,900 19,800	23,800 19,500	22,800 19,000	21,600 18,600	20,500 18,000	19,400 17,400	18,200 16,800	N/A	N/A
	85/72	Total Cooling Sensible Cooling	33,500 21,100	31,600 20,700	29,900 20,200	28,100 19,700	26,500 19,200	25,000 18,400	23,300 17,800	21,800 16,900	20,400 16,100	18,900 15,200	N/A	N/A
T42S1	75/62	Total Cooling Sensible Cooling	30,700 23,200	28,500 23,000	26,600 22,600	24,900 22,100	23,400 21,500	22,100 20,900	21,000 20,100	20,200 19,200	19,400 18,100	18,800 17,000	N/A	N/A
	80/67	Total Cooling Sensible Cooling	32,700 22,500	31,000 22,500	29,500 22,400	28,100 22,100	26,800 21,700	25,700 21,200	24,800 20,600	24,000 19,800	23,300 18,800	22,800 17,800	N/A	N/A
	85/72	Total Cooling Sensible Cooling	39,000 23,100	36,300 22,900	33,900 22,500	31,800 22,000	29,800 21,300	28,100 20,500	26,800 19,700	25,600 18,600	24,500 17,300	23,700 16,100	N/A	N/A
T48S1	75/62	Total Cooling Sensible Cooling	35,300 27,500	34,000 27,200	32,600 26,800	31,200 26,300	29,600 25,700	28,100 25,100	26,500 24,300	24,800 23,300	23,000 22,400	21,200 21,300	N/A	N/A
	80/67	Total Cooling Sensible Cooling	37,700 26,600	37,000 26,600	36,200 26,500	35,200 26,300	34,000 25,900	32,700 25,500	31,200 24,900	29,500 24,100	27,700 23,300	25,700 22,300	N/A	N/A
	85/72	Total Cooling Sensible Cooling	43,300 33,900	41,300 33,100	39,500 32,300	37,500 31,400	35,500 30,500	33,700 29,600	31,800 28,700	30,000 27,700	28,100 26,700	26,300 25,700	N/A	N/A
T60S1	75/62	Total Cooling Sensible Cooling	43,300 33,900	41,300 33,100	39,500 32,300	37,500 31,400	35,500 30,500	33,700 29,600	31,800 28,700	30,000 27,700	28,100 26,700	26,300 25,700	N/A	N/A
	80/67	Total Cooling Sensible Cooling	46,200 32,900	45,000 32,400	43,800 32,000	42,400 31,400	40,800 30,800	39,200 30,100	37,500 29,400	35,700 28,600	33,800 27,800	31,800 26,900	N/A	N/A
	85/72	Total Cooling Sensible Cooling	55,100 33,700	52,600 32,900	50,300 32,200	47,900 31,200	45,300 30,200	42,900 29,100	40,500 28,000	38,000 26,800	35,500 25,600	33,100 24,300	N/A	N/A

① Below 65°F, unit requires a factory or field installed low ambient control.

② Return air temperature °F.

Capacity Multiplier Factors			
% of Rated Airflow	-10	Rated	+10
Total BTUH	0.975	1.0	1.02
Sensible BTUH	0.950	1.0	1.05

Part Load Heating Application Rating & Outdoor Temperature °F*

MODEL		0°	5°	10°	15°	20°	25°	30°	35°	40°	45°	50°	55°	60°F
T30S1	BTUH	6,500	7,800	9,200	10,500	11,700	12,800	13,900	15,100	16,700	18,400	19,800	21,200	22,500
	WATTS	1750	1770	1790	1800	1810	1810	1810	1810	1850	1890	1920	1940	1950
	COP	1.09	1.30	1.51	1.71	1.90	2.08	2.26	2.45	2.65	2.86	3.03	3.21	3.39
T36S1	BTUH	6,700	8,400	10,100	11,800	13,400	14,900	16,500	18,000	20,000	21,900	23,700	25,400	27,100
	WATTS	1960	1970	1980	1990	2010	2040	2060	2090	2080	2080	2080	2100	2110
	COP	1.01	1.25	1.50	1.74	1.96	2.15	2.35	2.53	2.82	3.09	3.34	3.55	3.77
T42S1	BTUH	8,800	10,600	12,500	14,300	16,200	18,100	20,000	21,900	23,600	25,400	27,100	29,000	30,800
	WATTS	2340	2360	2390	2410	2410	2400	2380	2370	2450	2540	2590	2610	2640
	COP	1.11	1.32	1.54	1.74	1.97	2.21	2.47	2.71	2.83	2.93	3.07	3.26	3.42
T48S1	BTUH	10,800	12,900	15,100	17,200	18,900	20,300	21,600	23,000	26,300	29,500	32,100	34,300	36,400
	WATTS	2490	2520	2550	2580	2590	2600	2600	2600	2670	2740	2790	2820	2850
	COP	1.28	1.50	1.74	1.96	2.14	2.29	2.44	2.60	2.89	3.16	3.38	3.57	3.75
T60S1	BTUH	11,400	14,200	17,100	19,900	22,700	25,500	28,300	31,000	33,900	36,900	39,700	42,600	45,400
	WATTS	2860	2900	2950	2990	3040	3110	3170	3230	3250	3260	3290	3340	3380
	COP	1.17	1.44	1.70	1.96	2.19	2.41	2.62	2.82	3.06	3.32	3.54	3.74	3.94

* 70°F DB indoor return air at rated CFM includes defrost operation below 45°.

Indoor Blower Performance - CFM (0.00" — 0.50" H₂O) ①

Model	Rated ESP	① Max ESP	② Blower Only	③ Cooling & Heat Pump Stage 1	④ Cooling & Heat Pump Stage 2	④ Electric Heat
T30S	.10	.50	650	650	900	900
T36S	.15	.50	800	800	1100	1100
T42S	.15	.50	800	900	1250	1250
T48S	.20	.50	825	1000	1550	1550
T60S	.20	.50	850	1300	1650	1650

NOTE: These units are equipped with a variable speed (ECM) indoor motor that automatically adjusts itself to maintain approximately the same rate of indoor airflow in both heating & cooling, dry & wet coil conditions and at both 230/208 or 460 volts.

① Maximum ESP (inches WC) shown is with 2" thick disposable filter.

② Blower only CFM is the total air being circulated during continuous fan mode. Airflow remains constant.

③ Blower only CFM reduces during continuous fan mode. Requires wiring modification; consult Installation Instructions and Wiring Diagram.

④ CFM output on Cooling or Electric Heat.

Electric Heat Table - Refer to Electrical Specifications for Availability by Unit Model

Nominal KW	At 240V ①				At 208V ①				At 480V ②			At 460V ②		
	KW	1-Ph Amps	3-Ph Amps	Btuh	KW	1-Ph Amps	3-Ph Amps	Btuh	KW	3-Ph Amps	Btuh	KW	3-Ph Amps	Btuh
4.0	4.0	16.7		13,652	3.00	14.4		10,239						
5.0	5.0	20.8		17,065	3.75	18.0		12,799						
6.0	6.0		14.4	20,478	4.50		12.5	15,359	6.0	7.2	20,478	5.52	6.9	18,840
8.0	8.0	33.3		27,304	6.00	28.8		20,478						
9.0	9.0		21.7	30,717	6.75		18.7	23,038	9.0	10.8	30,717	8.28	10.4	28,260
10.0	10.0	41.7		34,130	7.50	36.1		25,598						
15.0	15.0	62.5	36.1	51,195	11.25	54.1	31.2	38,396	15.0	18.0	51,195	13.80	17.3	47,099
20.0	20.0	83.3		68,260	15.00	72.1		51,195						

① These electric heaters are available in 230/208V units only.

② These electric heaters are available in 480V units only.

Heater Packages - Field Installed for Standard & Dehumidification Models

- Designed for adding Electric Heat to 0 KW Units
- ETL US & Canada Listed
- Circuit Breaker Standard on 230/208V Models
- Toggle Disconnect Standard on 460V Models

Heat Pump Models	-A00 Models 230/208-1		-B00 Models 230/208-3		-C00 Models 460-3	
	Heater Model #	KW	Heater Model #	KW	Heater Model #	KW
T30S2	WMCB-05A	0Z	WMCB-03B	0Z	WMRD-01C	0
	EHT03H-A04B	4	EHT03H-B06B	6	EHT03H-C06	6
	EHT03H-AF8B	F8	EHT03H-B09B	9	EHT03H-C09	9
	EHT03H-AS8B	S8				
T36S1	WMCB-06A	0Z	WMCB-04B	0Z	WMRD-01C	0
	EHS03H-A05B	5	EHT05H-B06B	6	EHS05H-C06	6
	EHT05H-A08B	8	EHT05H-B09B	9	EHS03H-C09	9
	EHT05H-A10B	10	EHS05H-B15B	15	EHS03H-C15	15
	EHT05H-A15B	15				
T42S1	WMCB-06A	0Z	WMCB-05B	0Z	WMRD-01C	0
	EHS03H-A05B	5	EHS05H-B06B	6	EHS05H-C06	6
	EHT05H-A08B	8	EHS05H-B09B	9	EHS05H-C09	9
	EHT05H-A10B	10	EHS05H-B15B	15	EHS05H-C15	15
	EHT05H-A15B	15				
T48S1	WMCB-06A	0Z	WMCB-05B	0Z	WMRD-01C	0
	EHT06H-A05B	5	EHT06H-B06B	6	EHT06H-C06	6
	EHT06H-A08B	8	EHT06H-B09B	9	EHT06H-C09	9
	EHT06H-A10B	10	EHT06H-B15B	15	EHT06H-C15	15
	EHT06H-A15B	15				
T60S1	WMCB-09A	0Z	WMCB-06B	0Z	WMRD-01C	0
	EHT06H-A05B	5	EHT06H-B09B	9	EHT06H-C09	9
	EHT06H-A10B	10	EHT06H-B15B	15	EHT06H-C15	15
	EHT06H-A15B	15	EHT06H-B18B	18	EHT06H-C18	18
	EHT06H-A20B	20				

Clearances Required for Service Access and Adequate Condenser Airflow

MODELS	LEFT SIDE	RIGHT SIDE
All Models	20"	20"

- 1.) Follow all national, state, and local codes and regulations regarding the installation of heating and cooling equipment regarding Single Packaged Vertical Units (SPVU) including electrical access clearances.
- 2.) Bard recommends a minimum of 10 ft. between the unit front condenser air outlet and solid objects including fences, walls, bushes, and other airflow obstructions.
- 3.) Bard recommends a minimum of 15 ft. between the condenser air outlets of 2 units that are facing each other.
- 4.) Bard recommends a minimum clearance of 4" under the unit cabinet for condenser defrost drain age during heat pump operation.

Minimum Clearances Required to Combustible Materials

MODELS ①	SUPPLY AIR DUCT FIRST THREE FEET	CABINET
All Models	1/4"	0"

① Refer to the Installation Manual for more detailed information.

Dimensions of Basic Unit for Architectural & Installation Requirements (Nominal)

MODEL	WIDTH (W)	DEPTH (D)	HEIGHT (H)	SUPPLY		RETURN		E	F	G	I	J	K	L	M	N	O	P	Q	R	S	T
				A	B	C	B															
T30S2	38.200	17.125	70.563	7.88	27.88	13.88	27.88	40.00	10.88	25.75	17.93	26.75	28.75	29.25	27.00	2.63	39.13	22.75	9.14	5.00	12.00	5.00
T36S1 T42S1	42.075	22.432	84.875	9.88	29.88	15.88	29.88	43.88	13.56	31.66	30.00	32.68	26.94	34.69	32.43	3.37	43.00	23.88	10.00	1.44	16.00	1.88
T48S1 T60S1	42.075	22.432	93.000	9.88	29.88	15.88	29.88	43.88	13.56	37.00	30.00	40.81	35.06	42.81	40.56	3.37	43.00	31.00	10.00	1.44	16.00	10.00

All dimensions are in inches. Dimensional drawings are not to scale.

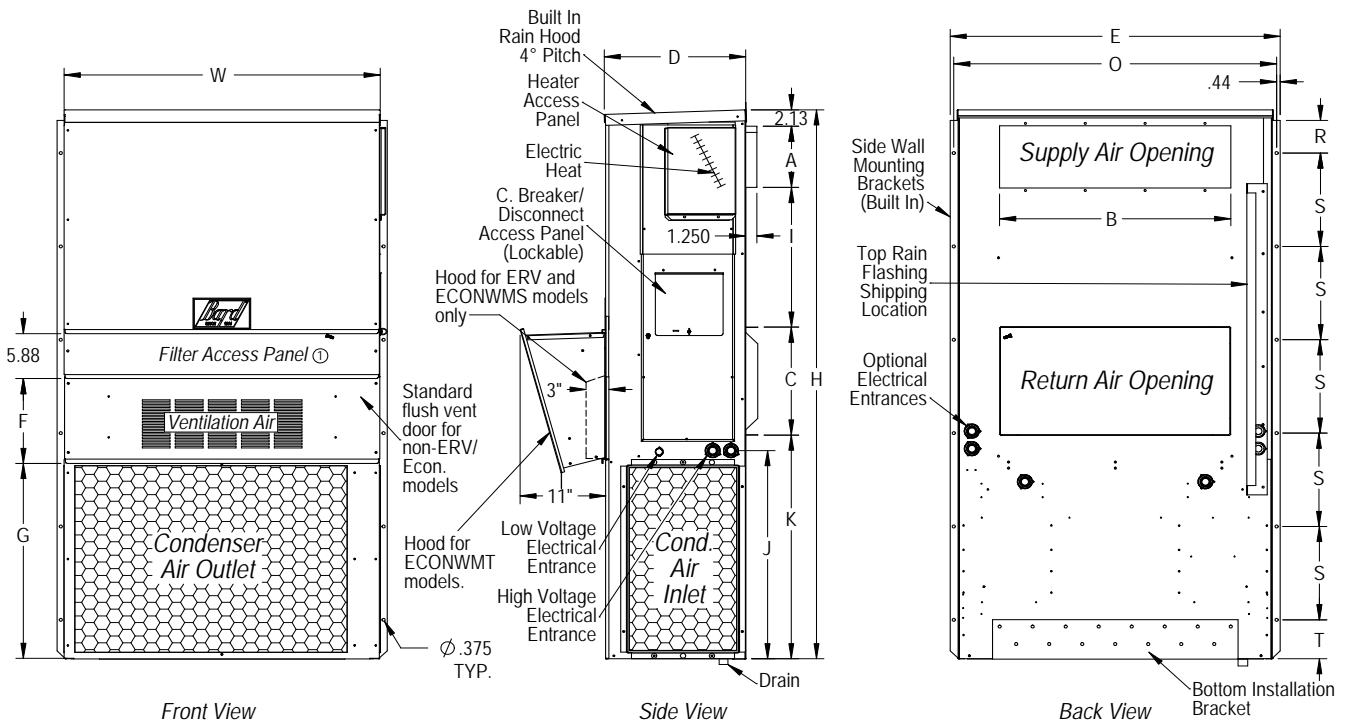

MS-2487 J

Unit Charge Rates

UNIT	Std. Unit - Lbs.	Dehum. Units - Lbs.
T30S1 - High Efficiency Step Capacity Quiet Climate HP	7.0625	6.625
T36S1 - High Efficiency Step Capacity Quiet Climate HP	10.75	11.5625
T42S1 - High Efficiency Step Capacity Quiet Climate HP	11.625	12.125
T48S1 - High Efficiency Step Capacity Quiet Climate HP	12.00	12.00
T60S1 - High Efficiency Step Capacity Quiet Climate HP	12.4375	12.4375

Heat Pump Wall-Mount Model Nomenclature

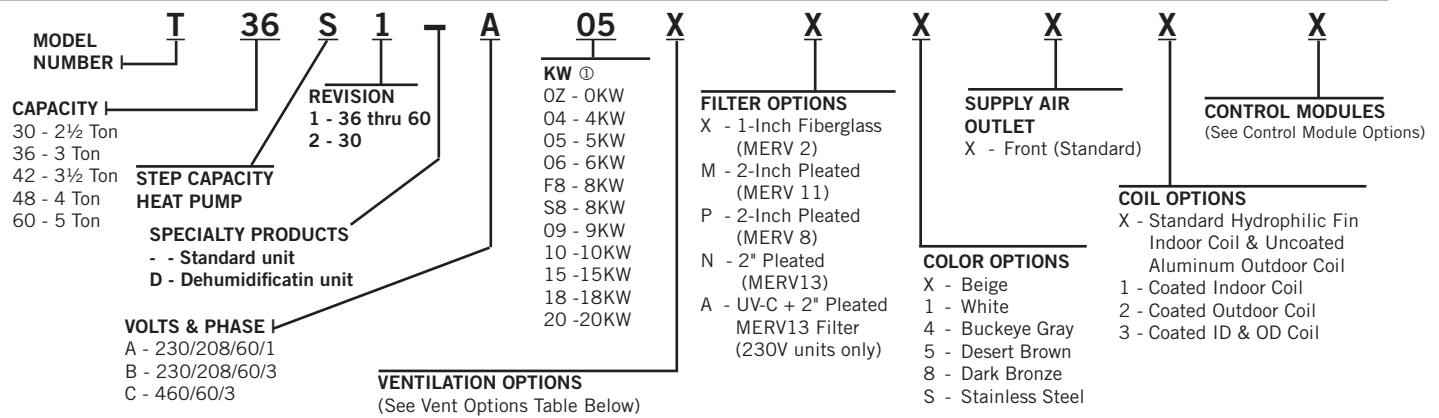

① For 0 KW and circuit breakers (230/208 volt) or toggle disconnect (460V) applications, insert 0Z in the KW field of the model number. See Pages 10 & 11.

Ventilation Options

Models	T30S2		T36S1, T42S1, T48S1, T60S1	
	Factory Installed Code No.	Field Installed Part No.	Factory Installed Code No.	Field Installed Part No.
Barometric Fresh Air Damper - Standard	X	BFAD-3	X	BFAD-5
Blank-Off Plate	B	BOP-3	B	BOP-5
Motorized Fresh Air Damper - No Exhaust ①	M	MFAD-3	M	MFAD-5
Commercial Ventilator - Spring Return w/Exhaust, Modulating or On/Off	V	CRVS-3A	V	CRVS-5A
Economizer - Standard - Enthalpy ④	S	ECONWMS-E3B ②	S	ECONWMS-E5B ②
Economizer - Equipment Bldg., Enthalpy ⑤	N/A	ECONWMT-E3B ②	N/A	ECONWMT-E5B ②
Economizer - Equipment Bldg., DB Temp ⑤	N/A	ECONWMT-T3B ②	N/A	ECONWMT-T5B ②
Energy Recovery Ventilator - 230 Volt ③	R	ERVF-A3 ①	R	ERVF-A5 ①
Energy Recovery Ventilator - 460 Volt ③	R	ERVF-C3 ①	R	ERVF-C5 ①
Door Kit for ERVF (Required)	N/A	WMDK3- ③	N/A	WMDK5- ③

- ① Intake and exhaust can be independently adjusted.
- ② Insert color to match unit ("X" = Beige; "4" = Buckeye Gray; etc.)
- ③ WMDK Door Kit must be ordered in addition to ERVF Assembly and color matched to unit ("X" = Beige; "4" = Buckeye Gray; etc.)
- ④ Units controlled by thermostats other than Bard 8403-060 or Bard CompleteStat™ may require Bard "8620-220 2-Stage Heat Pump with Economizer" Relay Kit for proper operation.
- ⑤ Partial Full Flow (75% of Rated Cooling Airflow). All ECONWMS versions have 3" deep air intake hood.

Heat Pump Control Modules

Low Pressure Control ①	High Pressure Control ①	Low Ambient Control and Relay ②	Start Kit ③	Start Kit ④	Outdoor Thermostat ⑤	Factory Installed Code	Field Installed Part
STD	STD					X	X
STD	STD	T30 ● All				E	CMH-32
STD	STD	T36-48 ● 230V				E	CMH-20
STD	STD	T30-48 ● 460V				E	CMH-21
STD	STD	T60 ● All				E	CMH-19
STD	STD		●			Field Installed Only	CMC-15 ③
STD	STD			●		Field Installed Only	SK111 ④
STD	STD				●	Field Installed Only	CMC-29

STD = Standard Equipment

CMH-32 for T30S2 230/460V ONLY

- ① The high & low pressure controls are auto reset. Operating circuit includes a lockout feature and is resettable from the wall thermostat. All low pressure controls use a timed bypass circuit to prevent nuisance tripping during low temperature start-up.
- ② The low ambient control includes an 8201-008 (fan relay) and permits cooling operation down to 0°F.
- ③ PTCR start kit can be used with all -A single phase models. Increases starting torque 2-3x. Not used for -B or -C three phase models. Do not use if SK111 is used.
- ④ Start capacitor and potential relay start kit can be used with all -A single phase models. Increases starting torque 9x. Not used for -B or -C three phase models. Do not use if CMC-15 is used.
- ⑤ ODT, Outdoor thermostat. Field-installed only. Bard Part #8403-061. Comes with weatherproof enclosure. Works in conjunction with multi-stage thermostats offered by Bard and can be configured for any or all of compressor cut-off in heat pump mode, minimum cooling mode and maximum electric heat operation based on outdoor temperature.
- ⑥ Freezestat is standard on dehumidification models. Field installed option for standard units.

NOTE: Standard heat pump control board has a 5-minute compressor anti-short cycle timer.



Bard Manufacturing Company, Inc.
 Bryan, Ohio 43506
 www.bardhvac.com

Due to our continuous product improvement policy, all specifications subject to change without notice.

Form No.
 S3447
 July 2022

Supersedes: S3447-0522