



THE WALL-MOUNT™ AIR CONDITIONERS - 10.0 EER, (60HZ)

Models W18AA to W72AA	Right-Side Control Panel
Models W18LA to W72LA	Left-Side Control Panel
1.5 to 6 Ton	(17,000 to 71,000 Btuh)

GREEN REFRIGERANT R-410A

The Bard Wall-Mount Air Conditioner is a self contained energy efficient system, which is designed to offer maximum indoor comfort at a minimal cost without using valuable indoor floor space or outside ground space. This unit is the ideal product for versatile applications such as: new construction, modular offices, school modernization, telecommunication structures, portable structures or correctional facilities. Factory or field installed accessories are available to meet specific job requirements.

Engineered Features

Aluminum Finned Copper Coils:

Grooved tubing and enhanced louvered fin for maximum heat transfer and energy efficiency.

Twin Blowers:

Move air quietly. Most models feature multispeed blower motors providing airflow adjustment for high and low static operation. Motor overload protection is standard on all models.

Air Conditioner Compressor:

Scroll Compressors eliminate need for crankcase heater. Standard on all models, except 5-Ton.

R-410A Refrigerant:

Designed with R-410A (HFC) non-ozone depleting refrigerant in compliance with the Montreal protocol and 2010 EPA requirements.

Phase Rotation Monitor:

Standard on all 3-phase scroll compressors. Protects against reverse rotation if power supply is not properly connected. Rotation protection is not required on the 5-Ton Unit(s).

Galvanized 20 Gauge Zinc Coated Steel Cabinet:

Cleaned, rinsed, sealed and dried before the polyurethane primer is applied. The cabinet is handsomely finished with a baked on textured enamel, which allows it to withstand 1000 hours of salt spray tests per ASTM B117-03.

Foil Faced Insulation:

Standard on all units.

Full Length Mounting Brackets:

Built into cabinet for improved appearance and easy installation.

NOTE: Bottom mounting bracket included to assist in installation.

Electrical Components:

Are easily accessible for routine inspection and maintenance through a right side, service panel opening. Features a lockable, hinged access cover to the circuit breaker or toggle disconnect switch.

Electric Heat Strips:

Features an automatic limit and thermal cut-off safety control. Heater packages can be factory or field installed.

Filter Service Door:

Separate service door provides easy access for filter change.

One Inch, Disposable Air Filters:

Are standard equipment. Optional one inch washable filters available and filter racks permit the addition of 2" pleated filter. Factory or field installed.

Condenser Fan and Motor Shroud Assembly:

Slides out for easy access.

Barometric Fresh Air Damper:

Standard on all units. Allows up to 25% outside fresh air. Optional ventilation packages available.

Built-in Circuit Breakers:

Standard on all electric heat versions of single (230/208 volt) and three phase (230/208 volt) equipment. Toggle disconnects are standard on all electric heat versions of three phase (460 volt) equipment.

Slope Top:

Standard feature for water run-off.

Top Rain Flashing:

Standard feature on all models.

Freezestat:

Standard on W72 models. Optional field installed CMC-29 can be used on all other models.

**Liquid Line Filter Drier:**

Standard on all units. Protects system against moisture.

Compressor Control Module:

Standard on all units. Built-in off-delay timer adjustable from 30 seconds to 5 minutes. 2-minute on-delay if power interrupt. 120-second bypass for low pressure control, and both soft and manual lockouts for high and low pressure controls. Alarm output for alarm relay.

High & Low Pressure Switches are Auto-Reset:

Standard on all units. Built-in lockout circuit resets from the room thermostat. Provides commercial quality protection to the compressor.



Bard is an
ISO 9001:2008
Certified Manufacturer

- Complies with efficiency requirements of ASHRAE/IESNA 90.1-2013.
- Certified to ANSI/ARI Standard 390-2003 for SPVU (Single Package Vertical Units).
- Intertek ETL Listed to Standard for Safety Heating and Cooling Equipment ANSI/UL 1995/CSA 22.2 No. 236-05, Fourth Edition.
- Commercial Product - Not intended for Residential application.

Capacity and Efficiency Ratings

Models	W18AA W18LA	W24AA W24LA	W30AA W30LA	W36AA W36LA	W42AA W42LA	W48AA W48LA	W60AA W60LA	W72AA W72LA
Cooling Capacity BTUH ①	17,000	24,600	30,000	36,400	41,500	48,000	59,000	71,000
EER	10.00	10.20	10.30	10.00	10.00	10.00	10.00	10.00

① Capacity is certified in accordance with ANSI/ARI Standard 390-2003.

② EER = Energy Efficiency Ratio and is certified in accordance with ANSI/ARI Standard 390-2003.

All ratings based on fresh air intake being 100% closed (no outside air introduction).

Specifications 1-1/2 Ton through 3 Ton

MODELS	W18AA-A W18LA-A	W24AA-A W24LA-A	W24AA-B W24LA-B	W24AA-C W24LA-C	W30AA-A W30LA-A	W30AA-B W30LA-B	W30AA-C W30LA-C	W36AA-A W36LA-A	W36AA-B W36LA-B	W36AA-C W36LA-C
Electrical Rating – 60 Hz	230/208 - 1	230/208 - 1	230/208 - 3	460 - 3	230/208 - 1	230/208 - 3	460 - 3	230/208 - 1	230/208 - 3	460 - 3
Operating Voltage Range	197-253	197-253	197-253	414-506	197-253	197-253	414-506	197-253	197-253	414-506
Compressor--Circuit A										
Voltage	230/208	230/208	230/208	460	230/208	230/208	460	230/208	230/208	460
Rated Load Amps	6.0/6.8	9.2/10.6	6.0/6.9	4.3	10.5/12.0	6.6/7.5	3.6	13.4/15	9.9/11.1	5.1
Branch Circuit Selection Current	9.0	12.8	8.3	5.1	16.0	10.0	4.7	17.9	13.2	6.0
Lock Rotor Amps	48/48	64/64	58/58	28	77/77	71/71	38	112/112	88/88	44
Compressor Type	Scroll	Scroll	Scroll	Scroll	Scroll	Scroll	Scroll	Scroll	Scroll	Scroll
Fan Motor & Condenser										
Fan Motor--HP--RPM	1/5 - 1075	1/5 - 1075	1/5 - 1075	1/5 - 1075	1/5 - 1075	1/5 - 1075	1/5 - 1075	1/5 - 1075	1/5 - 1075	1/5 - 1075
Fan Motor--Amps	1.2	1.2	1.2	0.8	1.5	1.5	0.8	1.5	1.5	0.8
Fan--DIA/CFM	18" - 1800	18" - 1800	18" - 1800	18" - 1800	20" - 2400	20" - 2400	20" - 2400	20" - 2200	20" - 2200	20" - 2200
Blower Motor & Evap.										
Blower Motor--HP-RPM-SPD	1/6-1100-2	1/6-1100-1	1/6-1100-1	1/6-1100-1	1/3-1100-2	1/3-1100-2	1/3-1100-2	1/3-1100-2	1/3-1100-2	1/3-1100-2
Blower Motor--Amps	0.8	1.1	1.1	.45	2.0	2.0	1.0	2.0	2.0	1.0
Motor Type	PSC	PSC	PSC	PSC	PSC	PSC	PSC	PSC	PSC	PSC
CFM Cooling & E.S.P. w/Filter (Rated-Wet Coil)	600 - .35	800 - .30	800 - .30	800 - .30	1000 - .45	1000 - .45	1000 - .45	1100 - .30	1100 - .30	1100 - .30
Filter Sizes (inches) STD.	16x25x1	16x25x1	16x25x1	16x25x1	16x30x1	16x30x1	16x30x1	16x30x1	16x30x1	16x30x1
Basic Unit Weight-LBS.										
Barometric Fresh Air Damper	3.5	3.5	3.5	3.5	4.0	4.0	4.0	4.0	4.0	4.0
Blank-Off Plate	1.0	1.0	1.0	1.0	1.0	1.0	1.0	1.0	1.0	1.0
Motorized Fresh Air Damper	10.0	10.0	10.0	10.0	11.0	11.0	11.0	11.0	11.0	11.0
Commercial Room Ventilator	69.0	69.0	69.0	69.0	75.0	75.0	75.0	75.0	75.0	75.0
Economizer	69.0	69.0	69.0	69.0	75.0	75.0	75.0	75.0	75.0	75.0
Energy Recovery Ventilator	50.0	50.0	50.0	50.0	56.0	56.0	56.0	56.0	56.0	56.0

Specifications 3-1/2 Ton through 6 Ton

MODELS	W42AA-A W42LA-A	W42AA-B W42LA-B	W42AA-C W42LA-C	W48AA-A W48LA-A	W48AA-B W48LA-B	W48AA-C W48LA-C	W60AA-A W60LA-A	W60AA-B W60LA-B	W60AA-C W60LA-C	W72AA-A W72LA-A	W72AA-B W72LA-B	W72AA-C W72LA-C
Electrical Rating – 60 Hz	230/208-1	230/208-3	460-3	230/208-1	230/208-3	460-3	230/208-1	230/208-3	460-3	230/208-1	230/208-3	460-3
Operating Voltage Range	197-253	197-253	414-506	197-253	197-253	414-506	197-253	197-253	414-506	197-253	197-253	414-506
Compressor--Circuit A												
Voltage	230/208	230/208	460	230/208	230/208	460	230/208	230/208	460	230/208	230/208	460
Rated Load Amps	15.1/16.9	10.4/11.6	5.2	17.3/19.6	11.8/13.3	5.8	21.8/23.2	13.9/14.8	7.4	27.7/30.4	16.9/18.5	8.8
Branch Circuit Selection Current	19.9	13.6	6.1	21.4	14.5	6.3	23.2	14.8	7.4	36.9	22.4	10.6
Lock Rotor Amps	109/109	83.1/83.1	41	135/135	98/98	55	130/130	110/110	55	185/185	149/149	75
Compressor Type	Scroll	Scroll	Scroll	Scroll	Scroll	Scroll	Recip.	Recip.	Recip.	Scroll	Scroll	Scroll
Fan Motor & Condenser												
Fan Motor--HP--RPM-SPD	1/3-825-2	1/3-825-2	1/3-825-1	1/3-825-2	1/3-825-2	1/3-825-1	1/3-825-2	1/3-825-2	1/3-825-1	1/2-1075-1	1/2-1075-1	1/2-1075-1
Fan Motor--Amps	2.6	2.6	1.3	2.6	2.6	1.3	2.5	2.5	1.3	4.0	4.0	1.7
Fan--DIA/CFM	24" - 2900	24" - 2900	24" - 2900	24" - 3000	24" - 3000	24" - 3000	24" - 3100	24" - 3100	24" - 3100	24" - 4000	24" - 4000	24" - 4000
Blower Motor & Evap.												
Blower Motor--HP-RPM-SPD	1/3-985-2	1/3-985-2	1/3-985-2	1/3-985-2	1/3-985-2	1/3-985-2	1/2-1070-2	1/2-1070-2	1/2-1070-2	3/4-1035-2	3/4-1035-2	3/4-1035-2
Blower Motor--Amps	2.3	2.3	1.2	2.3	2.3	1.2	3.5	3.5	2.1	6.3	6.3	1.7
Motor Type	PSC	PSC	PSC	PSC	PSC	PSC	PSC	PSC	PSC	ECM	ECM	ECM
CFM Cooling & E.S.P. w/Filter (Rated-Wet Coil)	1350 - .40	1350 - .40	1350 - .40	1550 - .35	1550 - .35	1550 - .35	1800 - .30	1800 - .30	1800 - .30	1900 - .25	1900 - .25	1900 - .25
Filter Sizes (inches) STD.	20x30x1	20x30x1	20x30x1	20x30x1	20x30x1	20x30x1	20x30x1	20x30x1	20x30x1	20x30x1	20x30x1	20x30x1
Basic Unit Weight-LBS.												
Barometric Fresh Air Damper	4.5	4.5	4.5	4.5	4.5	4.5	4.5	4.5	4.5	4.5	4.5	4.5
Blank-Off Plate	1.0	1.0	1.0	1.0	1.0	1.0	1.0	1.0	1.0	1.0	1.0	1.0
Motorized Fresh Air Damper	11.5	11.5	11.5	11.5	11.5	11.5	11.5	11.5	11.5	11.5	11.5	11.5
Commercial Room Ventilator	91.5	91.5	91.5	91.5	91.5	91.5	91.5	91.5	91.5	91.5	91.5	91.5
Economizer	91.5	91.5	91.5	91.5	91.5	91.5	91.5	91.5	91.5	91.5	91.5	91.5
Energy Recovery Ventilator	79.0	79.0	79.0	79.0	79.0	79.0	79.0	79.0	79.0	79.0	79.0	79.0

Ventilation System Packages

Bard Wall-Mounts are designed to provide optional ventilation packages to meet all of your ventilation and indoor air quality requirements. All units are equipped with a barometric fresh air damper as the standard ventilation package. All ventilation packages can be built-in at the factory or field-installed at a later date.

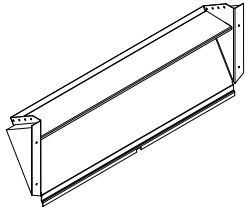

Barometric Fresh Air Damper

MIS-3754

BAROMETRIC FRESH AIR DAMPER - WBFAD

STANDARD

The barometric fresh air damper is a standard feature on all models. It is installed on the inside of the service door and allows outside ventilation air, up to 25% of the total airflow rating of the unit, to be introduced through the air inlet openings and to be mixed with the conditioned air. The damper opens during blower operation and closes when the blower is off. Adjustable blade stops allow different amounts of outside air to be introduced into the building and can be easily locked closed if required.

BLANK OFF PLATE - WBOP

OPTIONAL

A blank off plate is installed on the inside of the service door. It covers the air inlet openings, which restricts any outside air from entering the unit. The blank off plate should be utilized in applications where outside air is not required to be mixed with the conditioned air.

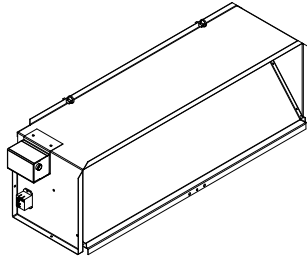

Motorized Fresh Air Damper

MIS-3755

MOTORIZED FRESH AIR DAMPER - WMFAD

OPTIONAL

The motorized fresh air damper is internally mounted behind the service door and allows outside ventilation air, up to 25% of the total airflow rating of the unit, to be introduced through the air inlet openings and to be mixed with the conditioned air. The two position damper can be fully open or closed. The damper blade is powered open by a 24VAC motor with spring return on power loss. The damper can be controlled by indoor blower operation or can be field connected to be managed based on building occupancy.

NOTE: The above vent systems are intake only without built-in exhaust capability. Building will likely require separate field installed barometric relief or mechanical exhaust elsewhere within the conditioned space. Balancing dampers in the return air grille may be required to achieve specified amount of outdoor air intake.

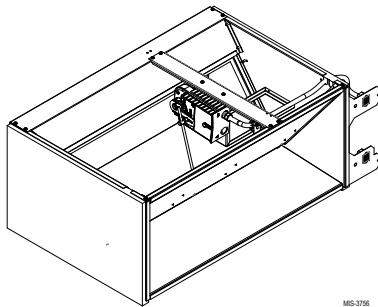

Commercial Room Ventilator

MIS-3756

COMMERCIAL ROOM VENTILATOR - WCRVPS

OPTIONAL

The built-in commercial room ventilator is internally mounted behind the service door and allows outside ventilation air, up to 100% of the total airflow rating of the unit. It includes a built-in exhaust air damper for room pressurization relief.

The commercial room ventilator (CRV) is a simple and innovative approach to improving the indoor air quality by providing fresh air intake and exhaust capability through the CRV. The damper can be easily adjusted to control the amount of fresh air supplied into the building. The CRV can be controlled by indoor blower operation or field controlled based on room occupancy. Two versions available (except on 1.5 and 2-Ton models). The CRV and CRVS are power open - spring return on power loss, with positive shut-off. Complies with ANSI/ASHRAE Standard 62.1 "Ventilation for Acceptable Indoor Air Quality".

Standard Features:

- Fully modulating
- Honeywell Hi-Torque Actuator with 0-10V signal input capability
- Hood not required.
- Simple single blade design
- Positive shut-off with non-stick gaskets
- Solid State Controller with occupancy CFM setting and modulating 4-20 mA thermostat signal input

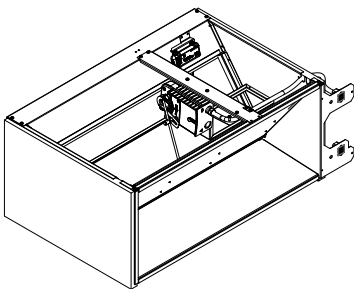

Economizer

MIS-3757

ECONOMIZER – WECO Series

OPTIONAL

The built-in economizer is internally mounted behind the service door and allows outside ventilation air, up to 100% of the total airflow rating of the unit. It includes a built-in exhaust air damper for room pressurization relief. The economizer is designed to provide "free cooling" when outside air conditions are cool and dry enough to satisfy cooling requirements without running the compressor. This in turn provides lower operating costs, while extending the life of the compressor.

Standard Features:

- Full rated outdoor intake
- Fully modulating
- Honeywell Hi-Torque Actuator
- 7" intake hood with filter
- Simple single blade design
- Positive shut-off with non-stick gaskets
- Electronic DB and/or Enthalpy sensors depending upon version
- Honeywell JADE electronic economizer module with precision settings and diagnostics
- DB or Enthalpy economizer versions available

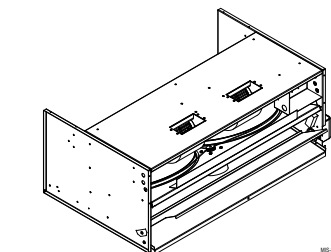

Energy Recovery Ventilator

MIS-3758

WALL-MOUNT ENERGY RECOVERY VENTILATOR - WERV

OPTIONAL

The wall-mount energy recovery ventilator (ERV) is a highly innovative approach to meeting indoor air quality ventilation requirements as established by ANSI/ASHRAE Standard 62.1. The ERV allows from 200 to 450 CFM (depending upon model) of fresh air and exhaust through the unit while maintaining superior indoor comfort and humidity levels. In most cases this can be accomplished without increasing equipment sizing or operating costs. Heat transfer efficiency is up to 67% during summer and 75% during winter conditions.

The ERV consists of a unique "rotary energy recovery cassette" that provides effective sensible and latent heat transfer capabilities during summer and winter conditions. Various control schemes are addressed including limiting ventilation during building occupancy only.

The ERV is designed to be internally mounted behind the service door in the W**A or W**L model wall-mount units. It can be built-in at the factory (W**A only) or field installed as an option. ERVP-*3 and ERVP-*5 can be independently adjusted for intake and exhaust rates.

The ERV's have exhaust gravity shut-off dampers and motorized air intake dampers for positive shut-off.

Wiring includes plug-in harnesses for easy vent installation and removal.

Economizer Performance Data

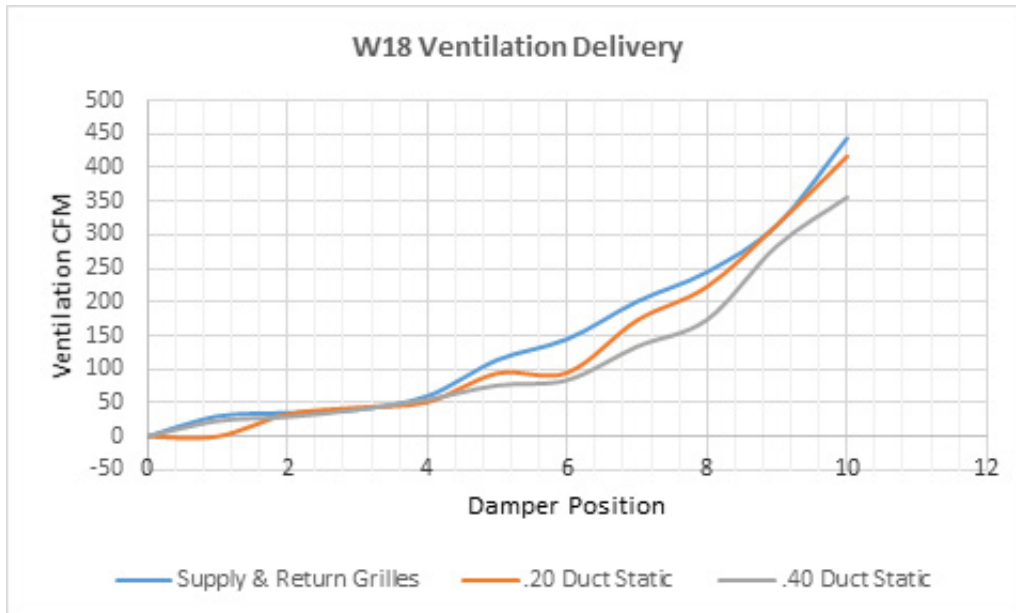

Airflow amounts less than 100 CFM may not be achievable.

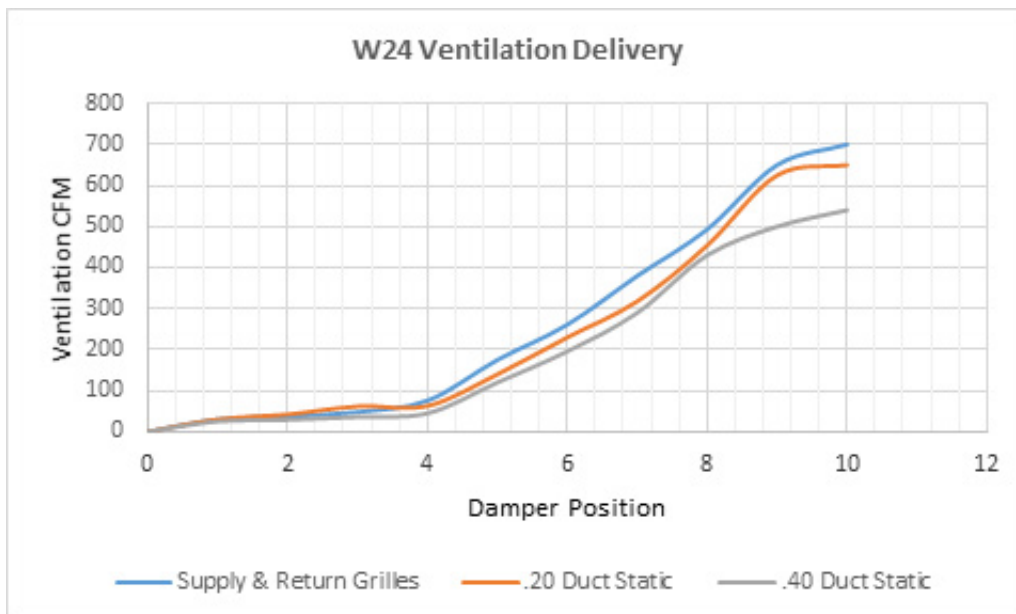

Airflow amounts less than 100 CFM may not be achievable.

Economizer Performance Data

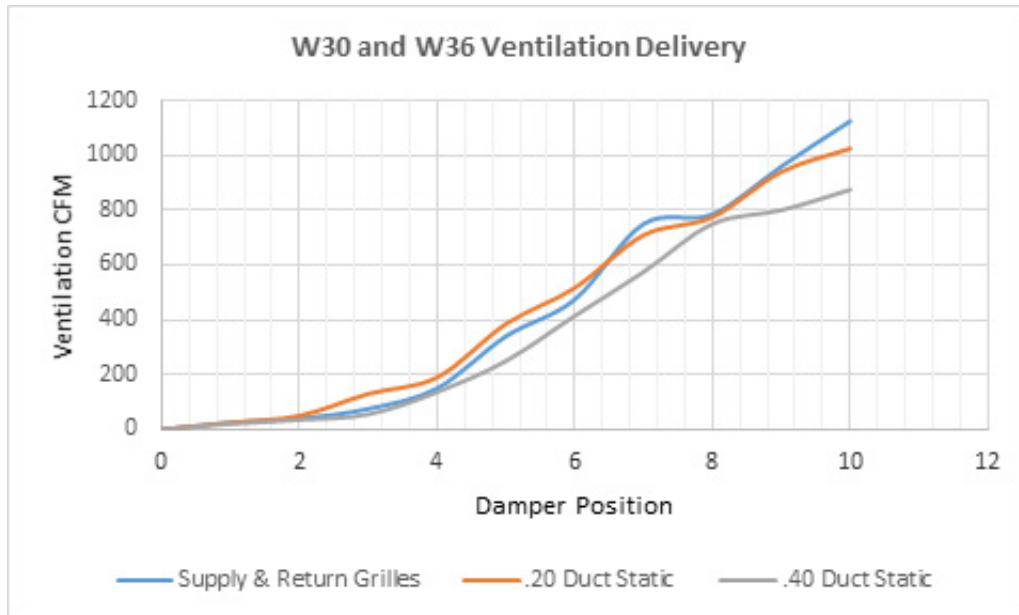

Airflow amounts less than 100 CFM may not be achievable.

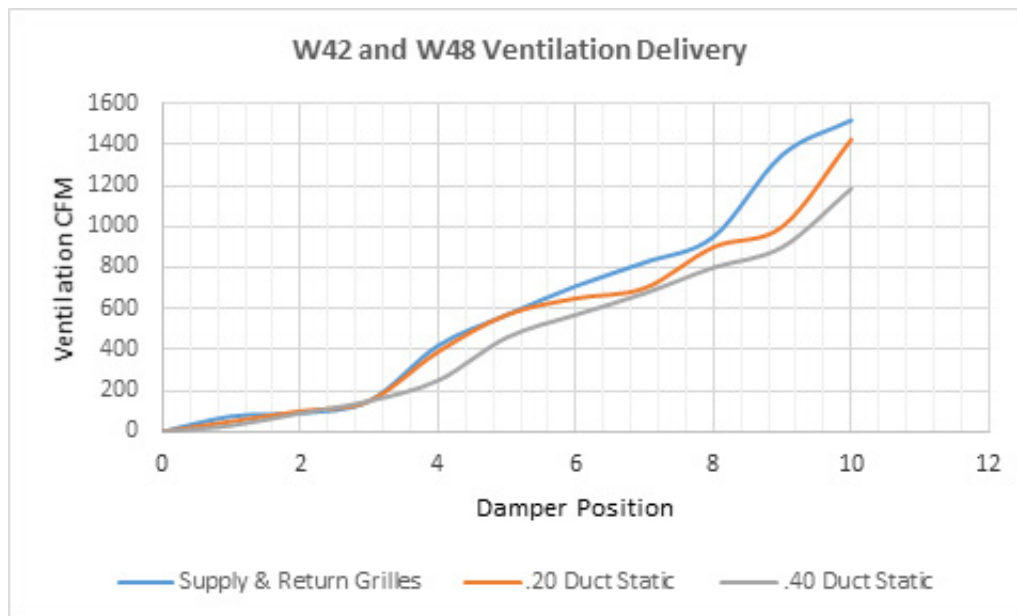

Airflow amounts less than 100 CFM may not be achievable.

Economizer Performance Data

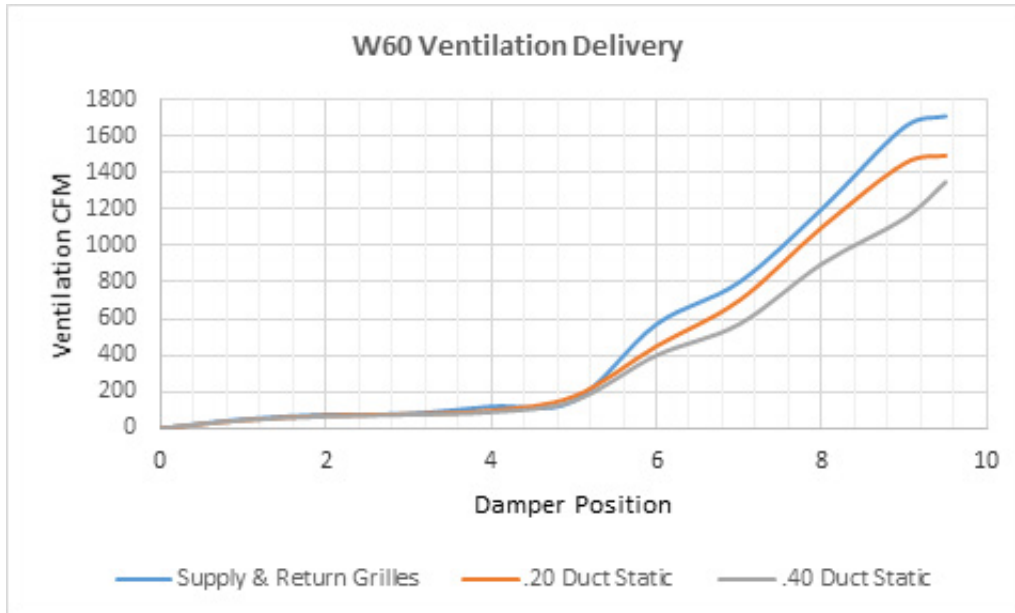

Airflow amounts less than 100 CFM may not be achievable.

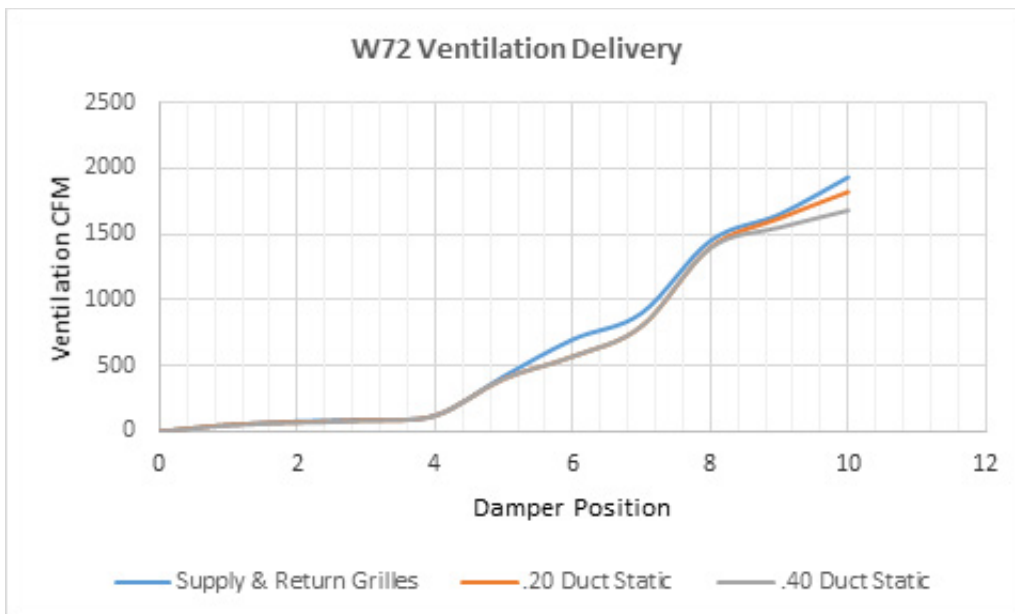

Airflow amounts less than 100 CFM may not be achievable.

Commercial Room Ventilator Performance Data

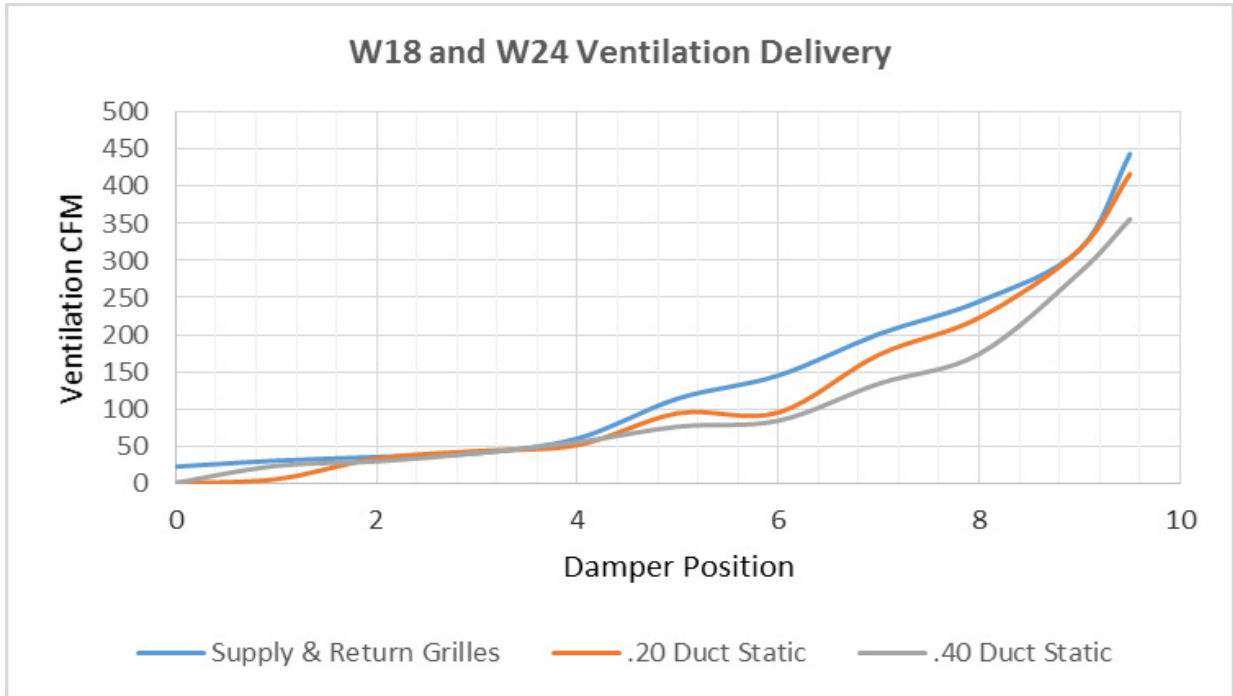

Airflow amounts less than 100 CFM may not be achievable.

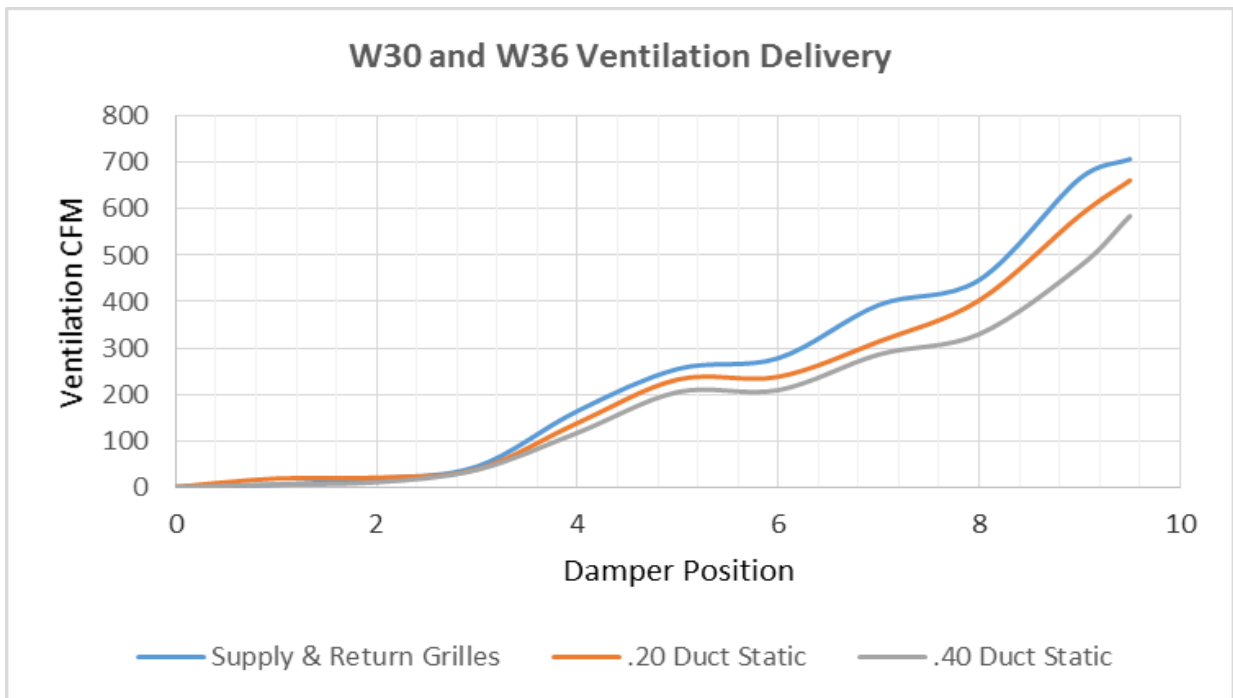

Airflow amounts less than 100 CFM may not be achievable.

Commercial Room Ventilator Performance Data

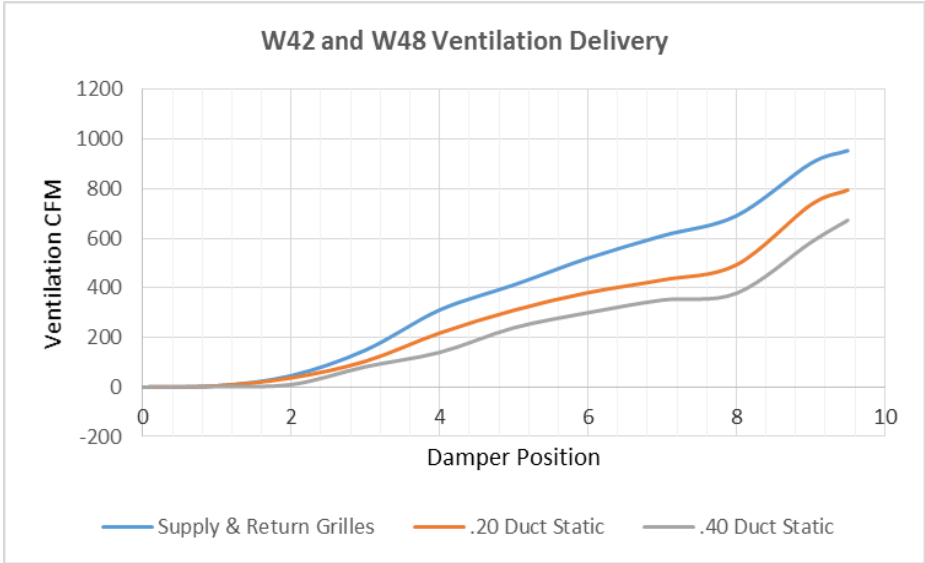

Airflow amounts less than 100 CFM may not be achievable.

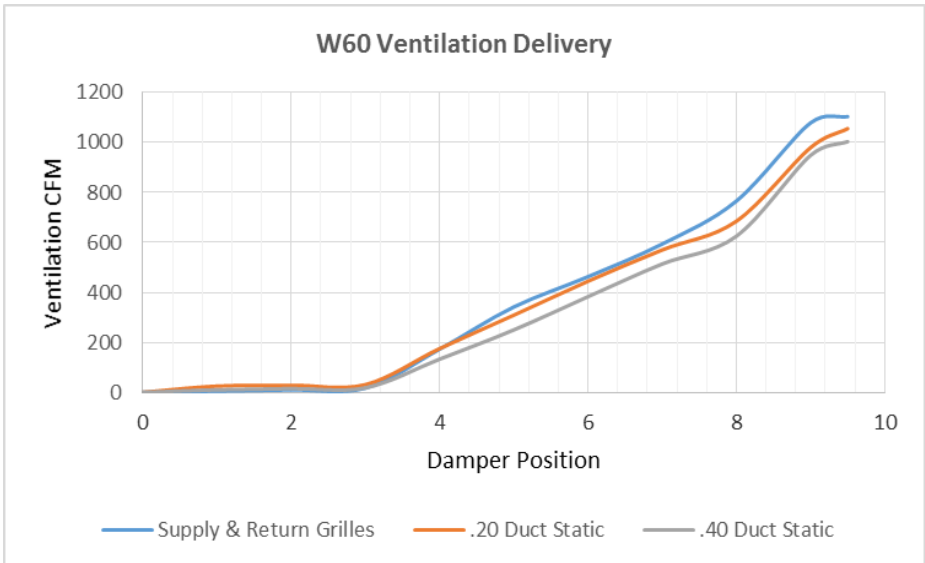

Airflow amounts less than 100 CFM may not be achievable.

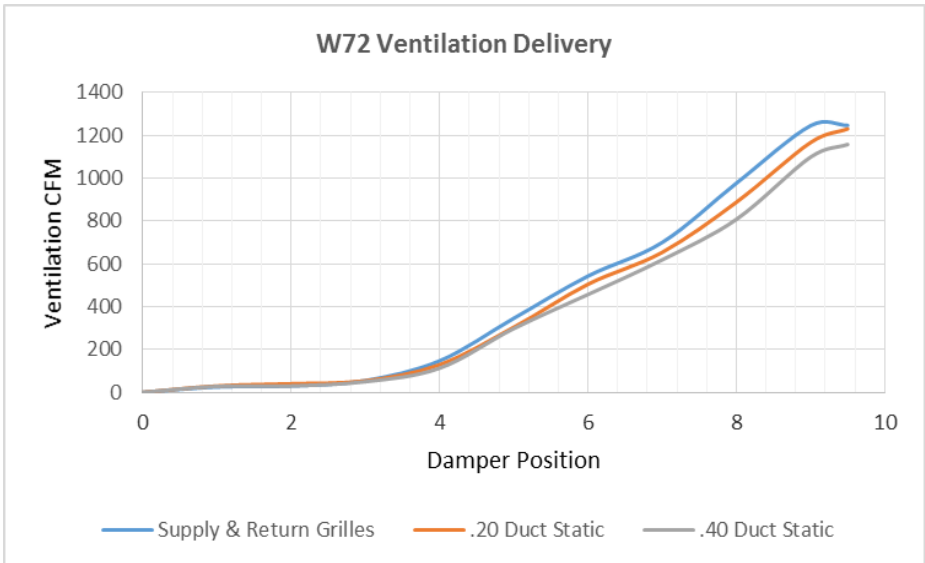

Airflow amounts less than 100 CFM may not be achievable.

Performance and Application Data- WERVP-A2

SUMMER COOLING PERFORMANCE (INDOOR DESIGN CONDITIONS 75°DB/62°WB)

Ambient O.D.		VENTILATION RATE -- 250 CFM 62% EFFICIENCY						VENTILATION RATE -- 225 CFM 63% EFFICIENCY						VENTILATION RATE -- 200 CFM 63% EFFICIENCY					
DB/WB	F	VLT	VLS	VLL	HRT	HRS	HRL	VLT	VLS	VLL	HRT	HRS	HRL	VLT	VLS	VLL	HRT	HRS	HRL
105	75	11925	8100	1325	7394	5022	822	10727	7287	3441	6758	4591	2168	9540	6480	3060	6010	4082	1928
	70	8100	8100	0	5022	5022	0	7287	7287	0	4591	4591	0	6480	6480	0	4082	4082	0
	65	8100	8100	0	5022	5022	0	7287	7287	0	4591	4591	0	6480	6480	0	4082	4082	0
100	80	17550	6750	10800	10881	4185	6696	15788	6072	9716	9946	3826	6121	14040	5400	8640	8845	3402	5443
	75	11925	6750	5175	7394	4185	3209	10727	6072	4655	6758	3826	2933	9540	5400	4140	6010	3402	2608
	70	6863	6750	113	4255	4185	70	6173	6072	101	3889	3826	64	5490	5400	90	3458	3402	56
	65	6750	6750	0	4185	4185	0	6072	6072	0	3826	3826	0	5400	5400	0	3402	3402	0
95	80	17550	5400	12150	10881	3348	7533	15788	4858	10930	9946	3060	6886	14040	4320	9720	8845	2722	6124
	75	11925	5400	6525	7394	3348	4046	10727	4858	5870	6758	3060	3698	9540	4320	5220	6010	2722	3289
	70	6863	5400	1463	4255	3348	907	6173	4858	1315	3889	3060	829	5490	4320	1170	3458	2722	737
	65	5400	5400	0	3348	3348	0	4858	4858	0	3060	3060	0	4320	4320	0	2722	2722	0
90	80	17550	4050	13500	10881	2511	8370	15788	3643	12145	9946	2295	7651	14040	3240	10800	8845	2041	6804
	75	11925	4050	7875	7394	2511	4883	10727	3643	7084	6758	2295	4463	9540	3240	6300	6010	2041	3969
	70	6863	4050	2813	4255	2511	1744	6173	3643	2530	3889	2295	1594	5490	3240	2250	3458	2041	1417
	65	4050	4050	0	2511	2511	0	3643	3643	0	2295	2295	0	3240	3240	0	2041	2041	0
85	80	17550	2700	14850	10881	1674	9207	15788	2429	13359	9946	1530	8416	14040	2160	11880	8845	1361	7484
	75	11925	2700	9225	7394	1674	5720	10727	2429	8298	6758	1530	5228	9540	2160	7380	6010	1361	4649
	70	6863	2700	4163	4255	1674	2581	6173	2429	3744	3889	1530	2359	5490	2160	3300	3458	1361	2098
	65	2700	2700	0	1674	1674	0	2429	2429	0	1530	1530	0	2160	2160	0	1361	1361	0
80	75	11925	1350	10575	7394	837	6557	10727	1214	9513	6758	765	5993	9540	1080	8460	6010	680	5330
	70	6863	1350	5513	4255	837	3418	6173	1214	4959	3889	765	3124	5490	1080	4410	3458	680	2778
	65	2363	1350	1013	1465	837	628	2125	1214	911	1339	765	547	1890	1080	810	1190	680	510
	60	1350	1350	0	837	837	0	1214	1214	0	765	765	0	1080	1080	0	680	680	0
75	70	6863	0	6863	4255	0	4255	6173	0	6173	6889	0	3889	5490	0	5490	3458	0	3458
	65	2363	0	2363	1465	0	1465	2125	0	2125	1339	0	1339	1890	0	1890	1190	0	1190
	60	0	0	0	0	0	0	0	0	0	0	0	0	0	0	0	0	0	0

WERVP-A2 WINTER HEATING PERFORMANCE (INDOOR DESIGN CONDITIONS 70°F DB)

Ambient O.D.	VENTILATION RATE					
	250 CFM 74% EFF.		225 CFM 75% EFF.		200 CFM 75% EFF.	
DB/°F	WVL	WHR	WVL	WHR	WVL	WHR
65	1350	999	1214	911	1080	810
60	2700	1998	2429	1822	2160	1620
55	4050	2997	3643	2733	3240	2430
50	5400	3996	4858	3643	4320	3240
45	6750	4995	6072	4554	5400	4050
40	8100	5994	7287	5465	6480	4860
35	9450	6993	8501	6376	7560	5670
30	10800	7992	9716	7287	8640	6480
25	12150	8991	10930	8198	9720	7290
20	13500	9990	12145	9108	10800	8100
15	14850	10989	13359	10019	11880	8910

LEGEND:

- VLT = Ventilation Load - Total
- VLS = Ventilation Load - Sensible
- VLL = Ventilation Load - Latent
- HRT = Heat Recovery - Total
- HRS = Heat Recovery - Sensible
- HRL = Heat Recovery - Latent
- WVL = Winter Ventilation Load
- WHR = Winter Heat Recovery

NOTE: Sensible performance only is shown for winter application.

Performance and Application Data- WERVP-3

SUMMER COOLING PERFORMANCE
(INDOOR DESIGN CONDITIONS 75°F DB/62°WB)

Ambient O.D.	VENTILATION RATE -- 400CFM						VENTILATION RATE -- 325 CFM						VENTILATION RATE -- 250 CFM																																														
	F	VLT	VLS	VLL	HRT	HRS	HRL	HRS	HRT	VLL	VLS	VLT	F	VLT	VLS	VLL	HRT	HRS	HRL	HRS	HRT	VLL	VLS	VLT																																			
75	19080	12960	6120	12020	8164	3835	6739	3182	11925	8100	3825	7751	5265	2486	75	19080	12960	6120	12020	8164	3835	6739	3182	11925	8100	3825	7751	5265	2486	75	19080	12960	6120	12020	8164	3835	6739	3182	11925	8100	3825	7751	5265	2486															
105	70	12960	12960	0	8164	8164	0	10530	10530	0	8100	8100	0	5265	5265	0	5265	5265	0	8100	8100	0	5265	5265	0																																		
65	12960	12960	0	8164	8164	0	10530	10530	0	8100	8100	0	5265	5265	0	5265	5265	0	8100	8100	0	5265	5265	0																																			
75	19080	10800	17280	17690	6804	10886	22815	8775	14040	14040	6750	6750	10800	11407	4387	7019	75	19080	10800	17280	17690	6804	10886	22815	8775	14040	14040	6750	6750	10800	11407	4387	7019	75	19080	10800	17280	17690	6804	10886	22815	8775	14040	14040	6750	6750	10800	11407	4387	7019									
100	70	10800	180	6717	6804	113	8921	8775	146	5616	112	4460	4387	73	100	70	10800	180	6717	6804	113	8921	8775	146	5616	112	4460	4387	73	100	70	10800	180	6717	6804	113	8921	8775	146	5616	112	4460	4387	73															
65	10800	10800	0	6804	6804	0	8775	8775	0	5616	5616	0	4387	4387	0	4387	4387	0	6750	6750	0	4387	4387	0																																			
60	10800	10800	0	6804	6804	0	8775	8775	0	5616	5616	0	4387	4387	0	4387	4387	0	6750	6750	0	4387	4387	0																																			
80	28080	6480	19440	17690	5443	12247	22815	7020	15795	14601	4492	10108	12150	5100	3510	7897	80	28080	6480	19440	17690	5443	12247	22815	7020	15795	14601	4492	10108	12150	5100	3510	7897	80	28080	6480	19440	17690	5443	12247	22815	7020	15795	14601	4492	10108	12150	5100	3510	7897									
75	19080	8640	10440	12020	5443	6577	15502	7020	8482	9921	4492	5428	11925	5400	6525	7751	3510	4241	75	19080	8640	10440	12020	5443	6577	15502	7020	8482	9921	4492	5428	11925	5400	6525	7751	3510	4241	75	19080	8640	10440	12020	5443	6577	15502	7020	8482	9921	4492	5428	11925	5400	6525	7751	3510	4241			
95	70	10800	8640	2340	6917	5443	1474	8921	7020	1901	5709	4492	1216	5862	5400	1462	4460	3510	950	95	70	10800	8640	2340	6917	5443	1474	8921	7020	1901	5709	4492	1216	5862	5400	1462	4460	3510	950	95	70	10800	8640	2340	6917	5443	1474	8921	7020	1901	5709	4492	1216	5862	5400	1462	4460	3510	950
65	8640	8640	0	5443	5443	0	7020	7020	0	4492	4492	0	5400	5400	0	3510	3510	0	5400	5400	0	3510	3510	0																																			
60	8640	8640	0	5443	5443	0	7020	7020	0	4492	4492	0	5400	5400	0	3510	3510	0	5400	5400	0	3510	3510	0																																			
80	28080	6480	19440	17690	5443	12247	22815	7020	15795	14601	4492	10108	12150	5100	3510	7897	80	28080	6480	19440	17690	5443	12247	22815	7020	15795	14601	4492	10108	12150	5100	3510	7897	80	28080	6480	19440	17690	5443	12247	22815	7020	15795	14601	4492	10108	12150	5100	3510	7897									
75	19080	6480	12600	12020	4082	7938	15502	5265	10237	9921	3369	6532	11925	4050	7875	7751	5118	75	19080	6480	12600	12020	4082	7938	15502	5265	10237	9921	3369	6532	11925	4050	7875	7751	5118	75	19080	6480	12600	12020	4082	7938	15502	5265	10237	9921	3369	6532	11925	4050	7875	7751	5118						
90	70	10800	6480	4500	6917	4082	2835	8921	5265	5709	3369	2340	6862	4050	2812	4460	2632	1828	90	70	10800	6480	4500	6917	4082	2835	8921	5265	5709	3369	2340	6862	4050	2812	4460	2632	1828	90	70	10800	6480	4500	6917	4082	2835	8921	5265	5709	3369	2340	6862	4050	2812	4460	2632	1828			
65	6480	6480	0	4082	4082	0	5265	5265	0	3369	3369	0	4050	4050	0	2632	2632	0	4050	4050	0	2632	2632	0																																			
60	6480	6480	0	4082	4082	0	5265	5265	0	3369	3369	0	4050	4050	0	2632	2632	0	4050	4050	0	2632	2632	0																																			
80	28080	4320	23760	17690	2721	14968	22815	3510	19305	14601	2246	12355	17550	2700	14850	11407	9632	80	28080	4320	23760	17690	2721	14968	22815	3510	19305	14601	2246	12355	17550	2700	14850	11407	9632	80	28080	4320	23760	17690	2721	14968	22815	3510	19305	14601	2246	12355	17550	2700	14850	11407	9632						
75	19080	4320	14760	12020	2721	9298	15502	3510	11982	9921	2246	7675	11925	2700	9225	7751	5996	75	19080	4320	14760	12020	2721	9298	15502	3510	11982	9921	2246	7675	11925	2700	9225	7751	5996	75	19080	4320	14760	12020	2721	9298	15502	3510	11982	9921	2246	7675	11925	2700	9225	7751	5996						
85	70	10800	4320	6660	6917	2721	4135	8921	3510	5411	5709	2246	3463	6862	2700	4162	4460	1755	2705	85	70	10800	4320	6660	6917	2721	4135	8921	3510	5411	5709	2246	3463	6862	2700	4162	4460	1755	2705	85	70	10800	4320	6660	6917	2721	4135	8921	3510	5411	5709	2246	3463	6862	2700	4162	4460	1755	2705
65	4320	4320	0	2721	2721	0	3510	3510	0	2246	2246	0	2700	2700	0	1755	1755	0	2700	2700	0	1755	1755	0																																			
60	4320	4320	0	2721	2721	0	3510	3510	0	2246	2246	0	2700	2700	0	1755	1755	0	2700	2700	0	1755	1755	0																																			
75	19080	2160	16920	12020	1360	10659	15502	1755	13747	9921	1123	8798	11925	1350	10575	7751	877	6873	75	19080	2160	16920	12020	1360	10659	15502	1755	13747	9921	1123	8798	11925	1350	10575	7751	877	6873	75	19080	2160	16920	12020	1360	10659	15502	1755	13747	9921	1123	8798	11925	1350	10575	7751	877	6873			
80	10800	2160	8820	6917	1360	5556	8921	1755	7166	5709	1123	4586	6862	1350	5512	4460	877	5583	80	10800	2160	8820	6917	1360	5556	8921	1755	7166	5709	1123	4586	6862	1350	5512	4460	877	5583	80	10800	2160	8820	6917	1360	5556	8921	1755	7166	5709	1123	4586	6862	1350	5512	4460	877	5583			
65	3780	2160	1620	1620	2381	1360	1020	2381	1360	1020	2381	1360	1020	2381	1360	1020	1535	877	5883	65	3780	2160	1620	1620	2381	1360	1020	2381	1360	1020	2381	1360	1020	2381	1360	1020	1535	877	5883	65	3780	2160	1620	1620	2381	1360	1020	2381	1360	1020	2381	1360	1020	2381	1360	1020	1535	877	5883
70	2160	2160	0	1360	1360	0	1755	1755	0	1123	1123	0	1350	1350	0	877	877	0	1350	1350	0	877	877	0																																			
70	10800	0	10800	6917	0	6917	8921	0	8921	5709	0	5709	6862	0	6862	4460	0	4460	70	10800	0	10800	6917	0	6917	8921	0	8921	5709	0	5709	6862	0	6862	4460	0	4460	70	10800	0	10800	6917	0	6917	8921	0	8921	5709	0	5709	6862	0	6862	4460	0	4460			
75	65	3780	0	3780	2381	0	2380	3071	0	3071	1965	0	1965	2362	0	2362	1535	0	1535	75	65	3780	0	3780	2381	0	2380	3071	0	3071	1965	0	1965	2362	0	2362	1535	0	1535	75	65	3780	0	3780	2381	0	2380	3071	0	3071	1965	0	1965	2362	0	2362	1535	0	1535

LEGEND:

- VLT = Ventilation Load - Total
- VLS = Ventilation Load - Sensible
- VLL = Ventilation Load - Latent
- HRT = Heat Recovery - Total
- HRS = Heat Recovery - Sensible
- HRL = Heat Recovery - Latent
- WVL = Winter Ventilation Load
- WHR = Winter Heat Recovery

NOTE: Sensible performance only is shown for winter application.

Performance and Application Data- WERVP-5

SUMMER COOLING PERFORMANCE
(INDOOR DESIGN CONDITIONS 75°F DB/62°WB)

Ambient O.D.	VENTILATION RATE -- 400CFM						VENTILATION RATE -- 325 CFM						VENTILATION RATE -- 250 CFM																															
	F	VLT	VLS	VLL	HRT	HRS	HRL	HRS	HRT	VLL	VLS	VLT	F	VLT	VLS	VLL	HRT	HRS	HRL	HRS	HRT	VLL	VLS	VLT																				
75	21465	14580	6884	13952	9477	4475	17887	12150	5737	11805	8018	3786	6512	3075	75	21465	14580	6884	13952	9477	4475	17887	12150	5737	11805	8018	3786	6512	3075	75	21465	14580	6884	13952	9477	4475	17887	12150	5737	11805	8018	3786	6512	3075
105	70	14580	14580	0	9477	9477	0	12150	12150	0	8018	8018	0	6512																														

Electrical Specifications — W**AA Series

MODEL	Rated Volts & Phase	No. Field Power Circuits	Single Circuit				Multiple Circuit														
			③ Minimum Circuit Ampacity	① Maximum External Fuse or Ckt. Brkr.	② Field Power Wire Size	② Ground Wire	③ Minimum Circuit Ampacity			① Maximum External Fuse or Ckt. Breaker			② Field Power Wire Size			② Ground Wire Size					
							Ckt. A	Ckt. B	Ckt. C	Ckt. A	Ckt. B	Ckt. C	Ckt. A	Ckt. B	Ckt. C	Ckt. A	Ckt. B	Ckt. C			
W18AA-A00, A02	230/208-1	1	16	20	12	12															
A05		1	30	30	10	10															
A08		1	46	50	8	10															
A10		1	56	60	6	10															
W24AA-A00, A02	230/208-1	1	21	30	10	10															
A04		1	25	30	10	10															
A05		1	30	30	10	10															
A08		1	46	50	8	10															
A10	1	56	60	6	10																
W24AA-B00, B02	230/208-3	1	15	20	12	12															
B06		1	22	25	10	10															
W24AA-C00, C02	460-3	1	9	15	14	14															
C06		1	11	15	14	14															
W30AA-A00*, A02*	230/208-1	1	26	35	8	10															
A05*		1	32	35	8	10															
A08		1	47	50	8	10															
A10*		1	58	60	6	10															
A15		1 or 2	84	90	4	8	58	26		60	30		6	10			10	10			
W30AA-B00*, B02*	230/208-3	1	19	20	12	12															
B06*		1	24	25	10	10															
B09*		1	33	35	8	10															
B15		1	51	60	6	10															
W30AA-C00*, C02*	460-3	1	9	15	14	14															
C06*		1	12	15	14	14															
C09*		1	17	20	12	12															
C12		1	21	25	10	10															
C15		1	26	30	10	10															
W36AA-A00*, A02*	230/208-1	1	29	35	8	10															
A05*		1	32	35	8	10															
A08		1	47	50	8	10															
A10*		1	58	60	6	10															
A15		1 or 2	84	90	4	8	58	26		60	30		6	10			10	10			
W36AA-B00*, B02*	230/208-3	1	23	30	10	10															
B06*		1	24	30	10	10															
B09*		1	33	35	8	10															
B15		1	51	60	6	10															
W36AA-C00*, C02*	460-3	1	11	15	14	14															
C06*		1	12	15	14	14															
C09*		1	17	20	12	12															
C12		1	21	25	10	10															
C15		1	26	30	10	10															
W42AA-A00, A02	230/208-1	1	32	50	8	10															
A05		1	32	50	8	10															
A10		1	58	60	6	10															
A15		1 or 2	84	90	4	8	58	26		60	30		6	10			10	10			
A20		1 or 2	110	125	2	2	58	52		60	60		6	6			10	10			
W42AA-B00, B02	230/208-3	1	25	35	8	10															
B06		1	25	35	8	10															
B09		1	33	35	8	10															
B15		1	51	60	6	10															
B18		1	60	60	6	10															
W42AA-C00, C02	460-3	1	12	15	14	14															
C09		1	17	20	12	12															
C15		1	26	30	10	10															
W48AA-A00, A02	230/208-1	1	34	50	8	10															
A05		1	34	50	8	10															
A10		1	58	60	6	10															
A15		1 or 2	84	90	4	8	58	26		60	30		6	10			10	10			
A20		1 or 2	110	125	2	2	58	52		60	60		6	6			10	10			
W48AA-B00, B02	230/208-3	1	26	35	8	10															
B06		1	26	35	8	10															
B09		1	33	35	8	10															
B15		1	51	60	6	10															
B18		1	60	60	6	10															
W48AA-C00, C02	460-3	1	12	15	14	14															
C09		1	17	20	12	12															
C15		1	26	30	10	10															
W60AA-A00, A02	230/208-1	1	38	60	8	10															
A05		1	38	60	8	10															
A10		1	60	60	6	10															
A15		1 or 2	86	90	3	8	60	26		60	30		6	10			10	10			
A20		1 or 2	112	125	2	2	60	52		60	60		6	6			10	10			
W60AA-B00, B02	230/208-3	1	27	40	8	10															
B06		1	27	40	8	10															
B09		1	35	40	8	10															
B15		1	53	60	6	10															
B18		2	N/A	N/A	N/A	N/A	35	28		40	30		8	10			10	10			
W60AA-C00, C02	460-3	1	14	20	12	12															
C09		1	18	20	12	12															
C15		1	27	30	10	10															
W72AA-A00, A02	230/208-1	1	58	60	6	10															
A05		1	58	60	6	10															
A10		1	62	70	6	8	58	26		60	30		6	10			10	10			
A15		1 or 2	88	90	3	8	58	52		60	60		6	6			10	10			
A20		1 or 3	114	125	2	2	58	52	52	60	60	60	6	6	6	6	10	10	10	10	
W72AA-B00, B02	230/208-3	1	40	60	8	10															
B06		1	40	60	8	10															
B09		1	40	60	8	10															
B15		1	55	60	6	10															
B18		2	N/A	N/A	N/A	N/A	40	28		60	30		8	10			10	10			
W72AA-C00, C02	460-3	1	18	25	10	10															
C09		1	18	25	10	10															
C15		1	27	30	10	10															

① Maximum size of the time delay fuse or circuit breaker for protection of field wiring conductors.

② Based on 75°C copper wire. All wiring must conform to the National Electrical Code and all local codes.

③ These "Minimum Circuit Ampacity" values are to be used for sizing the field power conductors. Refer to the National Electrical code (latest version), Article 310 for power conductor sizing.

* Top outlet supply option is available only factory installed and only on the selected models.

CAUTION: When more than one field power circuit is run through one conduit, the conductors must be derated. Pay special attention to Note 8 of Table 310 regarding Ampacity

Adjustment Factors

when more than three current carrying conductors are in a raceway.

IMPORTANT: While this electrical data is presented as a guide, it is important to electrically connect properly sized fuses and conductor wires in accordance with the National Electrical Code and all local codes.

Electrical Specifications – W**L Series

MODEL	Rated Volts & Phase	No. Field Power Circuits	Single Circuit				Dual Circuit											
			③ Minimum Circuit Ampacity	① Maximum External Fuse or Ckt. Brkr.	② Field Power Wire Size	② Ground Wire	③ Minimum Circuit Ampacity		① Maximum External Fuse or Ckt. Breaker		② Field Power Wire Size		② Ground Wire Size					
							Ckt. A	Ckt. B	Ckt. A	Ckt. B	Ckt. A	Ckt. B	Ckt. A	Ckt. B				
W18LA-A00, A0Z A05 A08 A10	230/208-1	1	16	20	12	12												
		1	30	30	10	10												
		1	46	50	8	10												
		1	56	60	6	10												
W24LA-A00, A0Z A05 A08 A10	230/208-1	1	21	30	10	10												
		1	30	30	10	10												
		1	46	50	8	10												
		1	56	60	6	10												
W24LA-B00, B0Z B06	230/208-3	1	15	20	12	12												
		1	22	25	10	10												
W24LA-C00, C0Z C06	460-3	1	9	15	14	14												
		1	11	15	14	14												
W30LA-A00, A0Z A05 A08 A10 A15	230/208-1	1	26	35	8	10												
		1	32	35	8	10												
		1	47	50	8	10												
		1	58	60	6	10												
		1 or 2	84	90	4	8	58	26	60	30	6	10	10	10				
W30LA-B00, B0Z B09 B15	230/208-3	1	19	20	12	12												
		1	33	35	8	10												
		1	51	60	6	10												
W30LA-C00, C0Z C09 C15	460-3	1	9	15	14	14												
		1	17	20	12	12												
		1	26	30	10	10												
W36LA-A00, A0Z A05 A10 A15	230/208-1	1	29	35	8	10												
		1	32	35	8	10												
		1	58	60	6	10												
		1	84	90	4	8	58	26	60	30	6	10	10	10				
		1 or 2	84	90	4	8												
W36LA-B00, B0Z B09 B15	230/208-3	1	23	30	10	10												
		1	33	35	8	10												
		1	51	60	6	10												
W36LA-C00, C0Z C09 C15	460-3	1	11	15	14	14												
		1	17	20	12	12												
		1	26	30	10	10												
W42LA-A00, A0Z A05 A10 A15	230/208-1	1	32	50	8	10												
		1	32	50	8	10												
		1	58	60	6	10												
		1	84	90	4	8	58	26	60	30	6	10	10	10				
		1 or 2	84	90	4	8												
W42LA-B00, B0Z B06 B09 B15	230/208-3	1	25	35	8	10												
		1	25	35	8	10												
		1	33	35	8	10												
		1	51	60	6	10												
W42LA-C00, C0Z C09 C15	460-3	1	12	15	14	14												
		1	17	20	12	12												
		1	26	30	10	10												
W48LA-A00, A0Z A05 A10 A15	230/208-1	1	34	50	8	10												
		1	34	50	8	10												
		1	58	60	6	10												
		1	84	90	4	8	58	26	60	30	6	10	10	10				
		1 or 2	84	90	4	8												
W48LA-B00, B0Z B06 B09 B15	230/208-3	1	26	35	8	10												
		1	26	35	8	10												
		1	33	35	8	10												
		1	51	60	6	10												
W48LA-C00, C0Z C09 C15	460-3	1	12	15	14	14												
		1	17	20	12	12												
		1	26	30	10	10												
W60LA-A00, A0Z A05 A10 A15	230/208-1	1	38	60	8	10												
		1	38	60	8	10												
		1	60	60	6	10												
		1	86	90	3	8	60	26	60	30	6	10	10	10				
		1 or 2	86	90	3	8												
W60LA-B00, B0Z B06 B09 B15	230/208-3	1	27	40	8	10												
		1	27	40	8	10												
		1	35	40	8	10												
		1	53	60	6	10												
W60LA-C00, C0Z C09 C15	460-3	1	14	20	12	12												
		1	18	20	12	12												
		1	27	30	10	10												
W72LA-A00, A0Z A05 A10 A15	230/208-1	1	58	60	6	10												
		1	58	60	6	10												
		1	62	70	6	8	58	26	60	30	6	10	10	10				
		1	88	90	3	8	58	52	60	60	6	6	10	10	10			
		1 or 2	88	90	3	8												
W72LA-B00, B0Z B06 B09 B15	230/208-3	1	40	60	8	10												
		1	40	60	8	10												
		1	40	60	8	10												
		1	55	60	6	10												
W72LA-C00, C0Z C09 C15	460-3	1	18	25	10	10												
		1	18	25	10	10												
		1	27	30	10	10												

- ① Maximum size of the time delay fuse or circuit breaker for protection of field wiring conductors.
- ② Based on 75°C copper wire. All wiring must conform to the National Electrical Code and all local codes.
- ③ These “Minimum Circuit Ampacity” values are to be used for sizing the field power conductors. Refer to the National Electrical code (latest version), Article 310 for power conductor sizing.

CAUTION: When more than one field power circuit is run through one conduit, the conductors must be derated. Pay special attention to Note 8 of Table 310 regarding Ampacity Adjustment Factors when more than three current carrying conductors are in a raceway.

IMPORTANT: While this electrical data is presented as a guide, it is important to electrically connect properly sized fuses and conductor wires in accordance with the National Electrical Code and all local codes.

Indoor Blower Performance (60 Hz) - CFM at Rated Voltage

Speed	W18			W24			W30			W36			W42			W48			W60			W72		
	High	Low ①	Single ①	High ①	Low	High ①	High ①	Low	High ①	High ①	Low	High ①	High ①	Low	High ①	High ①	Low	High ①	High ①	Low	High ①	High ①	Low	
ESP (Inch H2O)	Dry Coil	Wet Coil	Dry Coil	Wet Coil	Dry Coil	Wet Coil	Dry Coil	Wet Coil	Dry Coil	Wet Coil	Dry Coil	Wet Coil	Dry Coil	Wet Coil	Dry Coil	Wet Coil	Dry Coil	Wet Coil	Dry Coil	Wet Coil	Dry Coil	Wet Coil	Dry Coil	
0.0	985	720	1010	975	1445	1380	940	930	1400	1310	965	955	1980	1940	1800	1705	2000	1940	1750	1700	2105	2010	1540	1460
0.1	965	700	960	925	1385	1320	930	920	1340	1260	940	930	1905	1880	1700	1640	1910	1865	1675	1615	2045	1960	1480	1395
0.2	935	665	905	870	1305	1240	920	910	1265	1185	905	890	1820	1760	1615	1565	1820	1770	1600	1540	1970	1885	1400	1315
0.3	880	635	835	800	1220	1150	895	880	1180	1100	860	850	1735	1665	1530	1450	1720	1605	1500	1425	1895	1800	1300	1220
0.4	795	590	575	750	1125	1055	850	830	1080	1010	800	785	1615	1565	1425	1350	1575	1500	1375	1320	1800	1700	1220	1150
0.5	680	645	520	510	640	610	785	750	970	895	705	680	1510	1380	1100	1000	1420	1190	1075	1030	1705	1605	1110	1070

① Factory Connected Speed.

Above data is with 1" standard throwaway filter and 1" washable filter.
 For optional 2" pleated filter - reduce ESP by .15 in.
 See installation instructions for maximum ESP information on various KW application.

Electric Heat Table - Refer to Electrical Specifications for Availability by Unit Model

Nominal KW	At 240V (1)				At 208V (1)				At 480V (2)				At 460V (2)				
	Kw	1-Ph Amps	3-Ph Amps	Btuh	Kw	1-Ph Amps	3-Ph Amps	Btuh	Kw	3-Ph Amps	Btuh	Kw	3-Ph Amps	Btuh	Kw	3-Ph Amps	Btuh
4.0	4.0	16.7		13,652	3.00	14.4		10,239									
5.0	5.0	20.8		17,065	3.75	18.0		12,799									
6.0	6.0		14.4	20,478	4.50		12.5	15,359	6.0	7.2	20,478	5.52	6.9	18,840			
8.0	8.0	33.3		27,304	6.00	28.8		20,478									
9.0	9.0		21.7	30,717	6.75		18.7	23,038	9.0	10.8	30,717	8.28	10.4	28,260			
10.0	10.0	41.7		34,130	7.50	36.1		25,598									
15.0	15.0	62.5	36.1	51,195	11.25	54.1	31.2	38,396	15.0	18.0	51,195	13.80	17.3	47,099			
18.0	18.0		43.3	61,434	13.50		37.5	46,076	18.0	21.7	61,434	16.56	20.8	56,519			
20.0	20.0	83.3		68,260	15.00	72.1		51,195									

(1) These electric heaters are available in 230/208V units only.
 (2) These electric heaters are available in 480V units only.

Heater Packages - Field Installed "A" Series Right-Hand Units

- Designed for adding Electric Heat to 0 KW Units
- ETL US & Canada Listed
- Circuit Breaker Standard on 230/208V Models
- Toggle Disconnect Standard on 460V Models

Air Conditioner Models	-A00 Models 230/208-1		-B00 Models 230/208-3		-C00 Models 460-3	
	Heater Model #	KW	Heater Model #	KW	Heater Model #	KW
W18AA	EHW2TA-A05 EHW2TA-A08 EHW2TA-A10	5 8 10	N/A		N/A	
W24AA	EHWA24A-A04B EHW2TA-A05 EHW2TA-A08 EHW2TA-A10	4 5 8 10	EHW2TA-B06	6	EHW24B-C06	6
W30AA	EHW3TA-A05 EHW3TA-A08 EHW3TA-A10 EHW3TA-A15	5 8 10 15	EHW30A-B06 EHW3TA-B09 EHW3TA-B15	6 9 15	EHW3TA-C06 EHW3TA-C09 EHW3TA-C12 EHW3TA-C15	6 9 12 15
W36AA	EHW3TA-A05 EHW3TA-A08 EHW3TA-A10 EHW3TA-A15	5 8 10 15	EHW3TA-B06 EHW3TA-B09 EHW3TA-B15	6 9 15	EHW3TA-C06 EHW3TA-C09 EHW3TA-C12 EHW3TA-C15	6 9 12 15
W42AA W48AA	EHW4TA-A05 ① EHWA05-A10B ① EHWA05-A15B EHWA05-A20B	5 10 15 20	EHW4TA-B06 EHWA05-B09B ① EHWA05-B15B EHW4TA-B18 ①	6 9 15 18	EHW4TA-C09 ① EHW4TA-C15	9 15
W60AA	EHW5TA-A05 ① EHWA05-A10B ① EHWA05-A15B EHWA05-A20B	5 10 15 20	EHW60A-B09B ① EHWA05-B15B ① EHW5TA-B18 ①	9 15 18	EHW4TA-C09 ① EHW4TA-C15	9 15
W72AA	EHW5TA-A05 EHW72A-A10B EHW72A-A15B EHW72A-A20B	5 10 15 20	EHW6TA-B06 EHW70A-B09B EHWA05-B15B EHW6TA-B18	6 9 15 18	EHW4TA-C09 EHW4TA-C15	9 15

① These heater packages approved for use in dehumidification versions with hot gas reheat.

Heater Packages - Field Installed "L" Series Left-Hand Units

Air Conditioner Models	-A00 Models 230/208-1		-B00 Models 230/208-3		-C00 Models 460-3	
	Heater Model #	KW	Heater Model #	KW	Heater Model #	KW
W18LA	EHW2TA-A05L EHW2TA-A08L EHW2TA-A10L	5 8 10	N/A		N/A	
W24LA	EHW2TA-A05L EHW2TA-A08L EHW2TA-A10L	5 8 10	EHW2TA-B06L	6	N/A	
W30LA	EHW3TA-A05L EHW3TA-A08L EHW3TA-A10L EHW3TA-A15L	5 8 10 15	EHW3TA-B09L EHW3TA-B15L	9 15	EHW3TA-C09L EHW3TA-C15L	9 15
W36LA	EHW3TA-A05L EHW3TA-A10L EHW3TA-A15L	5 10 15	EHW3TA-B09L EHW3TA-B15L	9 15	EHW3TA-C09L EHW3TA-C15L	9 15
W42LA W48LA	EHW4TA-A05L EHWA05-A10LB EHWA05-A15LB	5 10 15	EHW4TA-B06 EHWA05-B09LB EHWA05-B15LB	6 9 15	EHW4TA-C09L EHW4TA-C15L	9 15
W60LA	EHW4TA-A05L EHWA05-A10LB EHWA05-A15LB	5 10 15	EHW60A-B09LB EHWA05-B15LB	9 15	EHW4TA-C09L EHW4TA-C15L	9 15
W72LA	EHW6TA-A05L EHW72A-A10LB EHW72A-A15LB	5 10 15	EHW70A-B09LB EHWA05-B15LB	9 15	EHW4TA-C09L EHW4TA-C15L	9 15

Clearances Required for Service Access and Adequate Condenser Inlet Airflow

MODELS	LEFT SIDE	RIGHT SIDE
W18LA, W24LA, W30LA, W36LA	20"	15"
W42LA, W48LA, W60LA, W72LA	20"	20"

NOTE: For side-by-side installation of two (2) WL models, there must be 20" between units. This can be reduced to 15" by using a WL model (left side compressor and controls) for the left unit and WA (right side compressor and controls) for right unit.

Minimum Clearances Required to Combustible Materials

MODELS ①	SUPPLY AIR DUCT FIRST THREE FEET	CABINET
W18LA, W24LA	0"	0"
W30LA, W36LA	1/4"	0"
W42LA, W48LA, W60LA, W72LA	1/4"	0"

① Refer to the Installation Manual for more detailed information.

Dimensions of W18-72L Basic Unit for Architectural & Installation Requirements (Nominal)

MODEL	WIDTH (W)	DEPTH (D)	HEIGHT (H)	SUPPLY		RETURN																
				A	B	C	B	E	F	G	I	J	K	L	M	N	O	P	Q	R	S	T
W18LA W24LA	33.300	17.125	74.563	7.88	19.88	11.88	19.88	35.00	10.88	29.75	20.56	30.75	32.06	33.25	31.00	2.63	34.13	26.06	10.55	4.19	12.00	9.00
W30LA W36LA	38.200	17.125	74.563	7.88	27.88	13.88	27.88	40.00	10.88	29.75	17.93	30.75	32.75	33.25	31.00	2.75	39.13	26.75	9.14	4.19	12.00	9.00
W42LA W48LA	42.075	22.432	84.875	9.88	29.88	15.88	29.88	43.88	13.56	31.66	30.00	32.68	26.94	34.69	32.43	3.37	43.00	23.88	10.00	1.44	16.00	1.88
W60LA W72LA	42.075	22.432	93.000	9.88	29.88	15.88	29.88	43.88	13.56	37.00	30.00	40.81	35.06	42.81	40.56	3.37	43.00	31.00	10.00	1.44	16.00	10.00

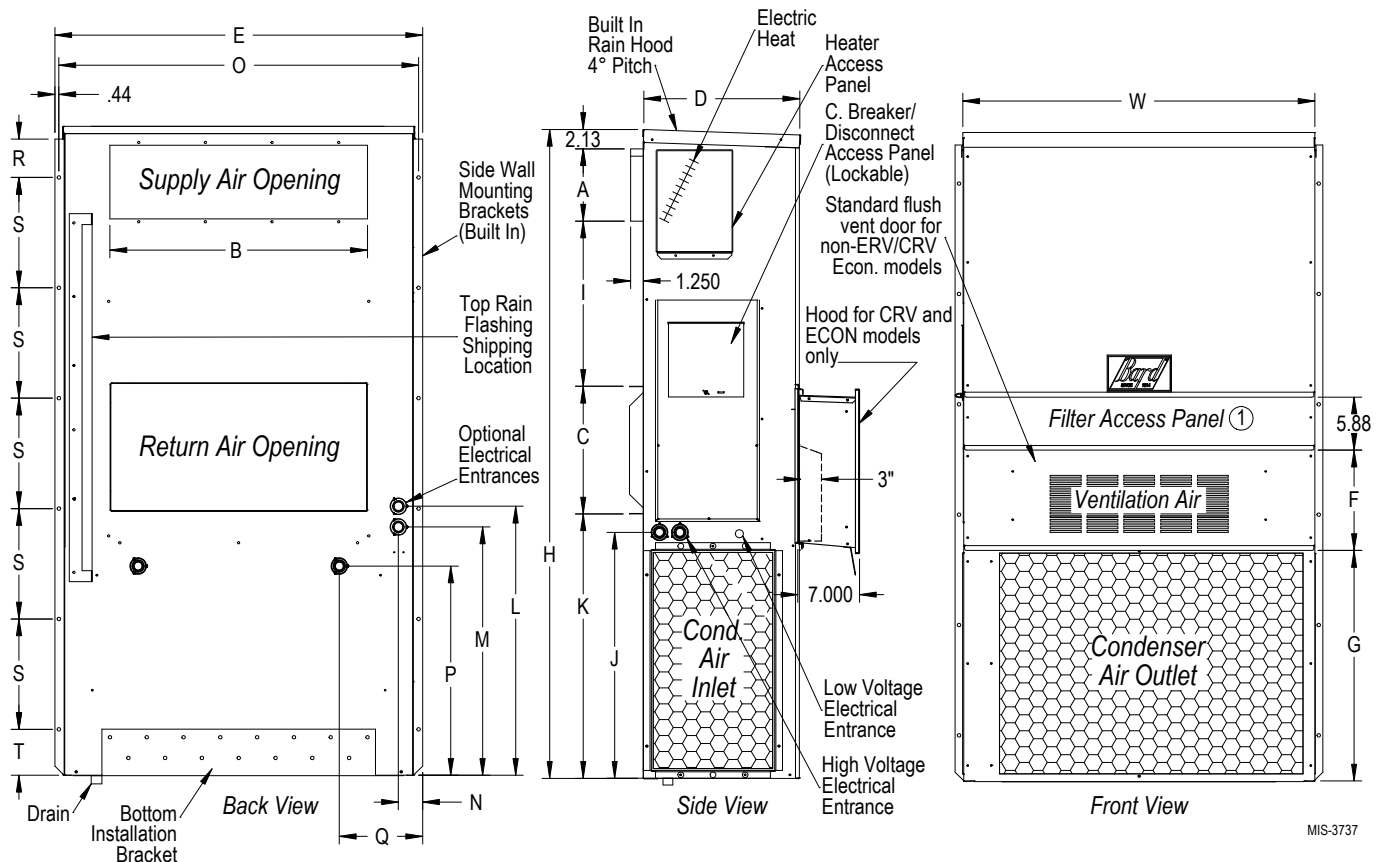

MIS-3737

① Not used when WECO Economizers installed. Filter access is through the WECO hood.

Cooling Application Data - Outdoor Temperature ①②

Model	Return Air (DB/WB) ③	Cooling Capacity	75°F	80°F	85°F	90°F	95°F	100°F	105°F	110°F	115°F	120°F	125°F
W18	75/62	Total Cooling	17400	16700	16200	15500	14800	14300	13600	12900	12300	11700	11000
		Sensible Cooling	13900	13700	13600	13400	13200	13000	12800	12500	12100	11600	11000
	80/67	Total Cooling	18500	18200	17900	17500	17000	16600	16000	15400	14800	14100	13300
		Sensible Cooling	13400	13400	13400	13400	13300	13200	13100	12900	12600	12400	12000
	85/72	Total Cooling	22100	21300	20600	19800	18900	18200	17300	16400	15600	14700	13700
		Sensible Cooling	13800	13600	13500	13300	13100	12800	12500	12100	11600	11200	10700
W24	75/62	Total Cooling	28100	26000	24100	22400	20900	19800	18800	18000	17300	16900	16600
		Sensible Cooling	22100	20600	19400	18400	17600	16900	16500	16200	16000	16000	15900
	80/67	Total Cooling	30000	28300	26700	25300	24600	23000	22100	21400	20800	20400	20200
		Sensible Cooling	21400	20200	19200	18400	17700	17200	16900	16700	16600	16700	17000
	85/72	Total Cooling	35800	33100	30700	28600	26700	25200	23900	22800	21900	21200	20800
		Sensible Cooling	21900	20500	19300	18300	17400	16700	16100	15700	15300	15100	15100
W30	75/62	Total Cooling	32500	30800	29100	27600	26100	24900	23700	22600	21500	20600	19600
		Sensible Cooling	24500	23600	22800	22100	21400	20900	20400	19900	19500	19200	18900
	80/67	Total Cooling	34700	33500	32300	31200	30000	29000	27900	26900	25800	24900	23900
		Sensible Cooling	23700	23100	22600	22100	21600	21200	20900	20500	20300	20100	19900
	85/72	Total Cooling	41400	39200	37100	35300	33400	31700	30100	28600	27100	25900	24600
		Sensible Cooling	24300	23500	22700	22000	21200	20500	19900	19200	18700	18200	17600
W36	75/62	Total Cooling	39500	37300	35200	33500	31800	30400	29100	27900	26900	26000	25200
		Sensible Cooling	29100	28100	27200	26300	25600	25000	24400	23900	23600	23200	22900
	80/67	Total Cooling	42100	40600	39100	37800	36400	35400	34300	33300	32300	31500	30700
		Sensible Cooling	28200	27500	26900	26300	25800	25400	25000	24700	24500	24300	24100
	85/72	Total Cooling	50200	47500	44900	42700	40600	38700	37000	35500	34000	32800	31600
		Sensible Cooling	28900	27900	27000	26100	25300	24600	23900	23200	22600	22000	21300
W42	75/62	Total Cooling	43600	41600	39700	38000	36200	34500	32900	31300	29800	28300	26900
		Sensible Cooling	34000	33200	32200	31400	30600	29900	29200	28600	27900	27300	26700
	80/67	Total Cooling	46500	45300	44100	42900	41500	40200	38800	37300	35800	34300	32700
		Sensible Cooling	33000	32500	31900	31400	30900	30400	29900	29500	29000	28600	28100
	85/72	Total Cooling	55400	53000	50700	48500	46100	44000	41900	39700	37600	35700	33700
		Sensible Cooling	33800	33000	32100	31200	30300	29400	28500	27700	26700	25900	24900
W48	75/62	Total Cooling	50500	48200	46000	43900	41800	39900	38000	36100	34400	32700	31000
		Sensible Cooling	38700	37800	36900	35900	35100	34200	33400	32500	31700	31000	30100
	80/67	Total Cooling	53900	52500	51100	49600	48000	46500	44800	43100	41400	39600	37800
		Sensible Cooling	37500	37000	36500	35900	35400	34800	34200	33600	33000	32400	31700
	85/72	Total Cooling	64200	61400	58700	56000	53300	50900	48300	45900	43500	41200	38900
		Sensible Cooling	38400	37600	36700	35700	34700	33700	32600	31500	30400	29300	28100
W60	75/62	Total Cooling	65500	61900	58400	55000	51800	48800	45900	43100	40500	37900	35300
		Sensible Cooling	49600	48200	46800	45300	43900	42500	41000	39600	38300	36800	35300
	80/67	Total Cooling	69900	67400	64800	62200	59000	56900	54200	51400	48700	45900	43000
		Sensible Cooling	48100	47200	46300	45300	44300	43200	42100	40900	39800	38500	37300
	85/72	Total Cooling	83300	78800	74400	70200	66100	62200	58400	54700	51200	47700	44200
		Sensible Cooling	49300	47900	46500	45000	43500	41800	40100	38400	36700	34800	33000
W72	75/62	Total Cooling	73800	70800	67800	64800	61800	59000	56100	53200	50400	47600	44800
		Sensible Cooling	55500	54000	52400	51000	49500	48200	46900	45600	44400	43200	42000
	80/67	Total Cooling	78800	77100	75300	73200	71000	68700	66200	63500	60700	57700	54600
		Sensible Cooling	53800	52900	51900	51000	50000	49100	48100	47100	46200	45200	44200
	85/72	Total Cooling	93900	90100	86500	82600	78900	75100	71400	67600	63800	60000	56200
		Sensible Cooling	55100	53700	52100	50700	49000	47500	45800	44200	42600	40800	39100

- ① Below 65°F, unit requires a factory or field installed low ambient control.
- ② Outdoor temperatures shown are measured at the condenser section air inlet.
- ③ Return air temperature °F.

Capacity Multiplier Factors			
% of Rated Airflow	-10	Rated	+10
Total BTUH	0.975	1.0	1.02
Sensible BTUH	0.950	1.0	1.05

Unit Charge Rates		
UNIT	Std. Unit - Lbs.	Dehum. Units - Lbs.
W18AA/LA - 10 EER Right & Left A/C	3.375	N/A
W24AA/LA - 10 EER Right & Left A/C	4.25	N/A
W30AA/LA - 10 EER Right & Left A/C	3.875	4.0625
W36AA/LA - 10 EER Right & Left A/C	4.3125	4.6875
W42AA/LA - 10 EER Right & Left A/C	4.8125	5.00
W48AA/LA - 10 EER Right & Left A/C	6.375	6.5
W60AA/LA - 10 EER Right & Left A/C	7.3125	8.625
W72AA/LA - 10 EER Right & Left A/C	8.8125	N/A

Bard W18AA Series Sound Data Matrix (dBA @ 10 feet)

Bard	Duct Free				Ducted - Front Outlet							
	Direct	WMICF5 Isolation Curb	WMICF5 Isolation Curb	WMICF5 Isolation Curb	Direct	WMICF5 Isolation Curb	Direct	WMICF5 Isolation Curb				
Unit Mounting	Direct	WMICF5 Isolation Curb	WMICF5 Isolation Curb	WMICF5 Isolation Curb	Direct	WMICF5 Isolation Curb	Direct	WMICF5 Isolation Curb				
Supply Air Treatment	Grille	Grille	Grille	WAPFB51 Free Blow Supply Plenum	Standard Supply Duct	Standard Supply Duct	Standard Supply Duct	WAPS51-G Supply Air Silencer				
Return Air Treatment	Grille	Grille	WAPR11-X Return Air Silencer	WAPR11-X Return Air Silencer	Grille	Grille	WAPR11-X Return Air Silencer	WAPR11-X Return Air Silencer				
Vent Option CFV	570 CFM	570 CFM	570 CFM	570 CFM	570 CFM	570 CFM	570 CFM	570 CFM				
Ventilation Only	42.3	39.6	39.2	35.8	40.5	35.6	37.1	33.8				
Full Load	47.3	45.2	42.9	42.0	46.2	44.0	43.1	42.2				
Integrated dBA	46.2	44.0	42.0	41.1	45.0	42.5	41.8	40.7				
Outdoor @ 10 Feet				62.8								
Sound Power Full Load	55.2			49.9	55.7			49.8				
Outdoor Sound Power					68.0							
Vent Option ERV	Low	Low	Low	Low	Low	Low	Low	Low				
Ventilation Only	48.7			42.1	48.3			39.6				
Full Load	49.4			44.2	49.8			42.5				
Integrated dBA	49.2			43.6	49.3			41.7				
Vent Option ERV	Med	Med	Med	Med	Med	Med	Med	Med				
Ventilation Only	50.3			42.0	50.2			39.7				
Full Load	50.8			44.5	51.1			42.5				
Integrated dBA	50.6			43.8	50.8			41.7				
Vent Option ERV	High	High	High	High	High	High	High	High				
Ventilation Only	51.5			41.4	50.9			40.1				
Full Load	51.9			44.3	52.4			42.3				
Integrated dBA	51.8			43.5	51.9			41.7				

Bard W18AA Series Sound Data Matrix (dBA @ 5 feet)

Bard	Duct Free				Ducted - Front Outlet							
	Direct	WMICF5 Isolation Curb	WMICF5 Isolation Curb	WMICF5 Isolation Curb	Direct	WMICF5 Isolation Curb	Direct	WMICF5 Isolation Curb				
Unit Mounting	Direct	WMICF5 Isolation Curb	WMICF5 Isolation Curb	WMICF5 Isolation Curb	Direct	WMICF5 Isolation Curb	Direct	WMICF5 Isolation Curb				
Supply Air Treatment	Grille	Grille	Grille	WAPFB51 Free Blow Supply Plenum	Standard Supply Duct	Standard Supply Duct	Standard Supply Duct	WAPS51-G Supply Air Silencer				
Return Air Treatment	Grille	Grille	WAPR11-X Return Air Silencer	WAPR11-X Return Air Silencer	Grille	Grille	WAPR11-X Return Air Silencer	WAPR11-X Return Air Silencer				
Vent Option CFV	570 CFM	570 CFM	570 CFM	570 CFM	570 CFM	570 CFM	570 CFM	570 CFM				
Ventilation Only	42.4	39.3	38.8	37.6	40.1	37.3	37.5	35.7				
Full Load	49.6	47.3	45.1	44.0	48.6	45.5	46.6	44.9				
Integrated dBA	48.2	45.8	43.8	42.7	47.1	44.0	45.1	43.4				
Outdoor @ 5 Feet					66.2							
Vent Option ERV	Low	Low	Low	Low	Low	Low	Low	Low				
Ventilation Only	51.8			43.7	51.9			42.5				
Full Load	52.3			45.8	52.5			45.2				
Integrated dBA	52.1			45.2	52.3			44.5				
Vent Option ERV	Med	Med	Med	Med	Med	Med	Med	Med				
Ventilation Only	53.3			43.7	53.6			43.4				
Full Load	53.8			46.1	54.1			45.5				
Integrated dBA	53.6			45.4	53.9			44.9				
Vent Option ERV	High	High	High	High	High	High	High	High				
Ventilation Only	54.5			43.9	54.3			44.1				
Full Load	55.1			46.1	55.4			45.7				
Integrated dBA	54.9			45.5	55.1			45.2				

¹ Integrated values calculated per ANSI/ASA S12.60-2009/Part 2, Section 5.2.2.1, Table 2 Triple Mode Type 3 HVAC System Duty Cycles: Ventilation 58%, Part Load 25%, Full Load 17%

² Integrated Sound Values are also applicable for use in learning spaces for LEED schools; EQ Prerequisite 3 - Minimum Acoustical Performance, OPTION 1. Using methods prescribed in ANSI S12.60, classroom must achieve a maximum background noise level of 45 dBA.

Results Referenced Were Recorded In The Bard Manufacturing Company, Inc. Sound Lab Facility
Actual Field Application Results May Vary With Classroom Design and Construction Methods
8/26/2016

Bard W24AA Series Sound Data Matrix (dBA @ 10 feet)

Bard	Duct Free				Ducted - Front Outlet							
	Unit Mounting	Direct	WMICF5 Isolation Curb	WMICF5 Isolation Curb	WMICF5 Isolation Curb	Direct	WMICF5 Isolation Curb	Direct	WMICF5 Isolation Curb			
Supply Air Treatment	Grille	Grille	Grille	WAPFB51 Free Blow Supply Plenum	Standard Supply Duct	Standard Supply Duct	Standard Supply Duct	WAP551-G Supply Air Silencer				
Return Air Treatment	Grille	Grille	WAPR11-X Return Air Silencer	WAPR11-X Return Air Silencer	Grille	Grille	WAPR11-X Return Air Silencer	WAPR11-X Return Air Silencer				
Vent Option CRV	570 CFM	570 CFM	570 CFM	570 CFM	570 CFM	570 CFM	570 CFM	570 CFM				
Ventilation Only	45.3	43.2	42.5	38.5	41.5	38.7	39.5	37.4				
Full Load	50.4	46.9	44.8	41.7	48.9	42.9	44.8	41.4				
Integrated dBA	49.2	46.0	44.1	40.9	47.5	41.9	43.6	40.4				
Outdoor @ 10 Feet				62.3								
Sound Power Full Load	58.0			49.2	57.6			48.3				
Outdoor Sound Power					71.0							
Vent Option ERV	Low	Low	Low	Low	Low	Low	Low	Low				
Ventilation Only	50.6			40.3	49.3			39.4				
Full Load	51.2			41.3	50.1			41.0				
Integrated dBA	51.0			41.0	49.8			40.5				
Vent Option ERV	Med	Med	Med	Med	Med	Med	Med	Med				
Ventilation Only	52.5			40.6	51.6			39.7				
Full Load	52.8			41.8	51.7			41.6				
Integrated dBA	52.7			41.4	51.7			41.0				
Vent Option ERV	High	High	High	High	High	High	High	High				
Ventilation Only	53.9			41.2	53.4			40.7				
Full Load	54.1			42.0	53.4			41.9				
Integrated dBA	54.0			41.7	53.4			41.5				

Bard W24AA Series Sound Data Matrix (dBA @ 5 feet)

Bard	Duct Free				Ducted - Front Outlet							
	Unit Mounting	Direct	WMICF5 Isolation Curb	WMICF5 Isolation Curb	WMICF5 Isolation Curb	Direct	WMICF5 Isolation Curb	Direct	WMICF5 Isolation Curb			
Supply Air Treatment	Grille	Grille	Grille	WAPFB51 Free Blow Supply Plenum	Standard Supply Duct	Standard Supply Duct	Standard Supply Duct	WAP551-G Supply Air Silencer				
Return Air Treatment	Grille	Grille	WAPR11-X Return Air Silencer	WAPR11-X Return Air Silencer	Grille	Grille	WAPR11-X Return Air Silencer	WAPR11-X Return Air Silencer				
Vent Option CRV	570 CFM	570 CFM	570 CFM	570 CFM	570 CFM	570 CFM	570 CFM	570 CFM				
Ventilation Only	48.3	46.2	44.5	44.0	44.2	40.4	41.7	39.2				
Full Load	52.4	49.7	46.9	40.3	51.9	45.4	47.5	44.0				
Integrated dBA	51.4	48.8	46.2	41.9	50.5	44.3	46.2	42.9				
Outdoor @ 5 Feet				67.1								
Vent Option ERV	Low	Low	Low	Low	Low	Low	Low	Low				
Ventilation Only	53.8			43.4	52.6			42.9				
Full Load	53.9			44.7	53.2			44.3				
Integrated dBA	53.9			44.3	53.0			43.9				
Vent Option ERV	Med	Med	Med	Med	Med	Med	Med	Med				
Ventilation Only	55.7			44.0	54.9			43.2				
Full Load	55.5			44.9	55.0			44.7				
Integrated dBA	55.6			44.6	55.0			44.2				
Vent Option ERV	High	High	High	High	High	High	High	High				
Ventilation Only	57.1			44.4	56.6			43.7				
Full Load	57.0			45.3	56.4			43.3				
Integrated dBA	57.0			45.0	56.5			43.4				

¹ Integrated values calculated per ANSI/ASA S12.60-2009/Part 2, Section 5.2.2.1, Table 2 Triple Mode Type 3 HVAC System Duty Cycles: Ventilation 58%, Part Load 25%, Full Load 17%

² Integrated Sound Values are also applicable for use in learning spaces for LEED schools; EQ Prerequisite 3 - Minimum Acoustical Performance, OPTION 1. Using methods prescribed in ANSI S12.60, classroom must achieve a maximum background noise level of 45 dBA.

Results Referenced Were Recorded In The Bard Manufacturing Company, Inc. Sound Lab Facility
Actual Field Application Results May Vary With Classroom Design and Construction Methods
8/5/2016

Bard W30AA Series Sound Data Matrix (dBA @ 10 feet)

Bard	Duct Free				Ducted - Front Outlet							
	Unit Mounting	Direct	WMICF5 Isolation Curb	WMICF5 Isolation Curb	WMICF5 Isolation Curb	Direct	WMICF5 Isolation Curb	Direct	WMICF5 Isolation Curb			
Supply Air Treatment	Grille	Grille	Grille	WAPFB51 Free Blow Supply Plenum	Standard Supply Duct	Standard Supply Duct	Standard Supply Duct	WAP551-G Supply Air Silencer				
Return Air Treatment	Grille	Grille	WAPR11-X Return Air Silencer	WAPR11-X Return Air Silencer	Grille	Grille	WAPR11-X Return Air Silencer	WAPR11-X Return Air Silencer				
Vent Option CRV	570 CFM	570 CFM	570 CFM	570 CFM	570 CFM	570 CFM	570 CFM	570 CFM				
Ventilation Only	51.2	48.7	48.2	43.6	46.5	42.6	45.0	42.6				
Full Load	52.9	50.4	48.8	44.6	47.3	44.7	48.5	43.2				
Integrated dBA	52.4	49.9	48.6	44.3	47.0	44.1	47.6	43.0				
Outdoor @ 10 Feet				67.1								
Sound Power Full Load	59.8			50.3	60.6			49.1				
Outdoor Sound Power					72.2							
Vent Option ERV	Low	Low	Low	Low	Low	Low	Low	Low				
Ventilation Only	54.3			45.6	52.5			45.0				
Full Load	54.3			46.1	52.5			45.1				
Integrated dBA	54.3			45.9	52.5			45.1				
Vent Option ERV	Med	Med	Med	Med	Med	Med	Med	Med				
Ventilation Only	55.8			46.0	54.1			45.5				
Full Load	55.5			46.2	54.0			45.2				
Integrated dBA	55.6			46.1	54.0			45.3				
Vent Option ERV	High	High	High	High	High	High	High	High				
Ventilation Only	57.8			46.5	56.9			45.4				
Full Load	57.4			46.7	56.1			45.9				
Integrated dBA	57.5			46.6	56.4			45.7				

Bard W30AA Series Sound Data Matrix (dBA @ 5 feet)

Bard	Duct Free				Ducted - Front Outlet							
	Unit Mounting	Direct	WMICF5 Isolation Curb	WMICF5 Isolation Curb	WMICF5 Isolation Curb	Direct	WMICF5 Isolation Curb	Direct	WMICF5 Isolation Curb			
Supply Air Treatment	Grille	Grille	Grille	WAPFB51 Free Blow Supply Plenum	Standard Supply Duct	Standard Supply Duct	Standard Supply Duct	WAP551-G Supply Air Silencer				
Return Air Treatment	Grille	Grille	WAPR11-X Return Air Silencer	WAPR11-X Return Air Silencer	Grille	Grille	WAPR11-X Return Air Silencer	WAPR11-X Return Air Silencer				
Vent Option CRV	570 CFM	570 CFM	570 CFM	570 CFM	570 CFM	570 CFM	570 CFM	570 CFM				
Ventilation Only	55.8	51.6	49.6	46.3	48.4	45.7	47.3	44.8				
Full Load	53.9	52.8	50.3	47.2	54.5	47.3	51.1	45.6				
Integrated dBA	54.6	52.4	50.1	46.9	53.2	46.8	50.1	45.3				
Outdoor @ 5 Feet				69.4								
Vent Option ERV	Low	Low	Low	Low	Low	Low	Low	Low				
Ventilation Only	57.6			48.9	54.5			48.3				
Full Load	57.4			49.3	55.5			48.6				
Integrated dBA	57.5			49.2	55.2			48.5				
Vent Option ERV	Med	Med	Med	Med	Med	Med	Med	Med				
Ventilation Only	58.9			49.4	56.7			48.9				
Full Load	58.7			49.8	57.1			48.8				
Integrated dBA	58.8			49.7	57.0			48.8				
Vent Option ERV	High	High	High	High	High	High	High	High				
Ventilation Only	60.8			50.0	59.8			49.2				
Full Load	60.6			50.3	59.2			49.8				
Integrated dBA	60.7			50.2	59.4			49.6				

¹ Integrated values calculated per ANSI/ASA S12.60-2009/Part 2, Section 5.2.2.1, Table 2 Triple Mode Type 3 HVAC System Duty Cycles: Ventilation 58%, Part Load 25%, Full Load 17%

² Integrated Sound Values are also applicable for use in learning spaces for LEED schools; EQ Prerequisite 3 - Minimum Acoustical Performance, OPTION 1. Using methods prescribed in ANSI S12.60, classroom must achieve a maximum background noise level of 45 dBA.

Results Referenced Were Recorded In The Bard Manufacturing Company, Inc. Sound Lab Facility
Actual Field Application Results May Vary With Classroom Design and Construction Methods
7/27/2016

Bard W36AA Series Sound Data Matrix (dBA @ 10 feet)

Bard	Duct Free				Ducted - Front Outlet							
	Unit Mounting	Direct	WMICF5 Isolation Curb	WMICF5 Isolation Curb	WMICF5 Isolation Curb	Direct	WMICF5 Isolation Curb	Direct	WMICF5 Isolation Curb			
Supply Air Treatment	Grille	Grille	Grille	WAPFB51 Free Blow Supply Plenum	Standard Supply Duct	Standard Supply Duct	Standard Supply Duct	WAP551-G Supply Air Silencer				
Return Air Treatment	Grille	Grille	WAPR11-X Return Air Silencer	WAPR11-X Return Air Silencer	Grille	Grille	WAPR11-X Return Air Silencer	WAPR11-X Return Air Silencer				
Vent Option CRV	570 CFM	570 CFM	570 CFM	570 CFM	570 CFM	570 CFM	570 CFM	570 CFM				
Ventilation Only	51.2	48.7	48.2	43.6	46.5	42.6	45.0	42.6				
Full Load	52.9	50.4	48.8	44.6	47.3	44.7	48.5	43.2				
Integrated dBA	52.4	49.9	48.6	44.3	47.0	44.1	47.6	43.0				
Outdoor @ 10 Feet				67.1								
Sound Power Full Load	59.8			50.3	60.6			49.1				
Outdoor Sound Power					72.2							
Vent Option ERV	Low	Low	Low	Low	Low	Low	Low	Low				
Ventilation Only	54.3			45.6	52.5			45.0				
Full Load	54.3			46.1	52.5			45.1				
Integrated dBA	54.3			45.9	52.5			45.1				
Vent Option ERV	Med	Med	Med	Med	Med	Med	Med	Med				
Ventilation Only	55.8			46.0	54.1			45.5				
Full Load	55.5			46.2	54.0			45.2				
Integrated dBA	55.6			46.1	54.0			45.3				
Vent Option ERV	High	High	High	High	High	High	High	High				
Ventilation Only	57.8			46.5	56.9			45.4				
Full Load	57.4			46.7	56.1			45.9				
Integrated dBA	57.5			46.6	56.4			45.7				

Bard W36AA Series Sound Data Matrix (dBA @ 5 feet)

Bard	Duct Free				Ducted - Front Outlet							
	Unit Mounting	Direct	WMICF5 Isolation Curb	WMICF5 Isolation Curb	WMICF5 Isolation Curb	Direct	WMICF5 Isolation Curb	Direct	WMICF5 Isolation Curb			
Supply Air Treatment	Grille	Grille	Grille	WAPFB51 Free Blow Supply Plenum	Standard Supply Duct	Standard Supply Duct	Standard Supply Duct	WAP551-G Supply Air Silencer				
Return Air Treatment	Grille	Grille	WAPR11-X Return Air Silencer	WAPR11-X Return Air Silencer	Grille	Grille	WAPR11-X Return Air Silencer	WAPR11-X Return Air Silencer				
Vent Option CRV	570 CFM	570 CFM	570 CFM	570 CFM	570 CFM	570 CFM	570 CFM	570 CFM				
Ventilation Only	55.8	51.6	49.6	46.3	48.4	45.7	47.3	44.8				
Full Load	53.9	52.8	50.3	47.2	54.5	47.3	51.1	45.6				
Integrated dBA	54.6	52.4	50.1	46.9	53.2	46.8	50.1	45.3				
Outdoor @ 5 Feet				69.4								
Vent Option ERV	Low	Low	Low	Low	Low	Low	Low	Low				
Ventilation Only	57.6			48.9	54.5			48.3				
Full Load	57.4			49.3	55.5			48.6				
Integrated dBA	57.5			49.2	55.2			48.5				
Vent Option ERV	Med	Med	Med	Med	Med	Med	Med	Med				
Ventilation Only	58.9			49.4	56.7			48.9				
Full Load	58.7			49.8	57.1			48.8				
Integrated dBA	58.8			49.7	57.0			48.8				
Vent Option ERV	High	High	High	High	High	High	High	High				
Ventilation Only	60.8			50.0	59.8			49.2				
Full Load	60.6			50.3	59.2			49.8				
Integrated dBA	60.7			50.2	59.4			49.6				

¹ Integrated values calculated per ANSI/ASA S12.60-2009/Part 2, Section 5.2.2.1, Table 2 Triple Mode Type 3 HVAC System Duty Cycles: Ventilation 58%, Part Load 25%, Full Load 17%

² Integrated Sound Values are also applicable for use in learning spaces for LEED schools; EQ Prerequisite 3 - Minimum Acoustical Performance, OPTION 1. Using methods prescribed in ANSI S12.60, classroom must achieve a maximum background noise level of 45 dBA.

Bard W42AA Series Sound Data Matrix (dBA @ 10 feet)

Bard	Duct Free				Ducted - Front Outlet							
	Unit Mounting	Direct	WMICF5 Isolation Curb	WMICF5 Isolation Curb	WMICF5 Isolation Curb	Direct	WMICF5 Isolation Curb	Direct	WMICF5 Isolation Curb			
Supply Air Treatment	Grille	Grille	Grille	WAPFB51 Free Blow Supply Plenum	Standard Supply Duct	Standard Supply Duct	Standard Supply Duct	WAP551-G Supply Air Silencer				
Return Air Treatment	Grille	Grille	WAPR11-X Return Air Silencer	WAPR11-X Return Air Silencer	Grille	Grille	WAPR11-X Return Air Silencer	WAPR11-X Return Air Silencer				
Vent Option CRV	570 CFM	570 CFM	570 CFM	570 CFM	570 CFM	570 CFM	570 CFM	570 CFM				
Ventilation Only	50.5	49.1	47.3	44.1	46.3	40.6	44.7	40.1				
Full Load	54.5	53.3	48.0	45.3	53.4	44.1	52.6	43.6				
Integrated dBA	53.5	52.3	47.8	44.9	52.0	43.2	51.1	42.7				
Outdoor @ 10 Feet				66.9								
Sound Power Full Load Outdoor	63.3			52.9	61.5			48.2				
Sound Power Outdoor					73.7							
Vent Option ERV	Low	Low	Low	Low	Low	Low	Low	Low				
Ventilation Only	51.8			44.9	50.0			41.1				
Full Load	51.9			47.2	50.3			43.5				
Integrated dBA	51.9			46.5	50.2			42.8				
Vent Option ERV	Med	Med	Med	Med	Med	Med	Med	Med				
Ventilation Only	52.7			45.2	50.5			41.5				
Full Load	52.6			46.5	51.7			43.6				
Integrated dBA	52.6			46.1	51.3			43.0				
Vent Option ERV	High	High	High	High	High	High	High	High				
Ventilation Only	53.7			46.0	52.7			42.4				
Full Load	54.1			47.1	53.0			44.4				
Integrated dBA	54.0			46.8	52.9			43.8				

Bard W42AA Series Sound Data Matrix (dBA @ 5 feet)

Bard	Duct Free				Ducted - Front Outlet							
	Unit Mounting	Direct	WMICF5 Isolation Curb	WMICF5 Isolation Curb	WMICF5 Isolation Curb	Direct	WMICF5 Isolation Curb	Direct	WMICF5 Isolation Curb			
Supply Air Treatment	Grille	Grille	Grille	WAPFB51 Free Blow Supply Plenum	Standard Supply Duct	Standard Supply Duct	Standard Supply Duct	WAP551-G Supply Air Silencer				
Return Air Treatment	Grille	Grille	WAPR11-X Return Air Silencer	WAPR11-X Return Air Silencer	Grille	Grille	WAPR11-X Return Air Silencer	WAPR11-X Return Air Silencer				
Vent Option CRV	570 CFM	570 CFM	570 CFM	570 CFM	570 CFM	570 CFM	570 CFM	570 CFM				
Ventilation Only	53.0	50.6	48.2	46.8	48.7	43.4	47.4	42.8				
Full Load	58.2	56.3	49.3	48.1	58.0	47.4	56.7	46.6				
Integrated dBA	57.0	55.1	49.0	47.7	56.5	46.4	55.2	45.6				
Outdoor @ 5 Feet				69.3								
Vent Option ERV	Low	Low	Low	Low	Low	Low	Low	Low				
Ventilation Only	54.5			46.8	53.0			44.4				
Full Load	55.4			50.1	54.1			46.0				
Integrated dBA	55.1			49.2	53.8			45.5				
Vent Option ERV	Med	Med	Med	Med	Med	Med	Med	Med				
Ventilation Only	55.5			48.0	54.1			44.8				
Full Load	56.1			49.4	55.8			46.7				
Integrated dBA	55.9			49.0	55.3			46.1				
Vent Option ERV	High	High	High	High	High	High	High	High				
Ventilation Only	57.0			49.2	56.1			45.7				
Full Load	57.5			50.2	57.1			47.5				
Integrated dBA	57.3			49.9	56.8			47.0				

¹ Integrated values calculated per ANSI/ASA S12.60-2009/Part 2, Section 5.2.2.1, Table 2 Triple Mode Type 3 HVAC System Duty Cycles: Ventilation 58%, Part Load 25%, Full Load 17%

² Integrated Sound Values are also applicable for use in learning spaces for LEED schools; EQ Prerequisite 3 - Minimum Acoustical Performance, OPTION 1. Using methods prescribed in ANSI S12.60, classroom must achieve a maximum background noise level of 45 dBA.

Bard W48AA Series Sound Data Matrix (dBA @ 10 feet)

Unit Mounting	Duct Free				Ducted - Front Outlet							
Supply Air Treatment	Direct	WMICF5 Isolation Curb	WMICF5 Isolation Curb	WMICF5 Isolation Curb	Direct	WMICF5 Isolation Curb	Direct	WMICF5 Isolation Curb				
Return Air Treatment	Grille	Grille	Grille	WAPFB51 Free Blow Supply Plenum	Standard Supply Duct	Standard Supply Duct	Standard Supply Duct	WAPSS1-G Supply Air Silencer				
Vent Option CRV	Grille	Grille	WAPR11-X Return Air Silencer	WAPR11-X Return Air Silencer	Grille	Grille	WAPR11-X Return Air Silencer	WAPR11-X Return Air Silencer				
Vent Option CRV	570 CFM	570 CFM	570 CFM	570 CFM	570 CFM	570 CFM	570 CFM	570 CFM				
Ventilation Only	51.3	49.3	47.9	43.2	46.9	45.7	42.3	41.6				
Full Load	54.9	52.8	49.0	44.8	53.3	52.9	46.8	43.8				
Integrated dBA	54.0	51.9	48.7	44.3	52.0	51.5	45.7	43.2				
Outdoor @ 10 Feet				65.9								
Sound Power Full Load	63.2			53.1				49.6				
Outdoor Sound Power					71.6							
Vent Option ERV	Low	Low	Low	Low	Low	Low	Low	Low				
Ventilation Only	52.2			50.6	49.5			41.9				
Full Load	51.9			50.7	52.3			43.5				
Integrated dBA	52.0			50.7	51.5			43.0				
Vent Option ERV	Med	Med	Med	Med	Med	Med	Med	Med				
Ventilation Only	52.4			48.5	51.6			42.1				
Full Load	52.3			49.5	53.1			45.8				
Integrated dBA	52.3			49.2	52.6			44.9				
Vent Option ERV	High	High	High	High	High	High	High	High				
Ventilation Only	53.4			47.1	52.8			42.6				
Full Load	53.6			47.8	54.5			44.7				
Integrated dBA	53.5			47.6	54.0			44.1				

Bard W48AA Series Sound Data Matrix (dBA @ 5 feet)

Unit Mounting	Duct Free				Ducted - Front Outlet							
Supply Air Treatment	Direct	WMICF5 Isolation Curb	WMICF5 Isolation Curb	WMICF5 Isolation Curb	Direct	WMICF5 Isolation Curb	Direct	WMICF5 Isolation Curb				
Return Air Treatment	Grille	Grille	Grille	WAPFB51 Free Blow Supply Plenum	Standard Supply Duct	Standard Supply Duct	Standard Supply Duct	WAPSS1-G Supply Air Silencer				
Vent Option CRV	Grille	Grille	WAPR11-X Return Air Silencer	WAPR11-X Return Air Silencer	Grille	Grille	WAPR11-X Return Air Silencer	WAPR11-X Return Air Silencer				
Vent Option CRV	570 CFM	570 CFM	570 CFM	570 CFM	570 CFM	570 CFM	570 CFM	570 CFM				
Ventilation Only	53.9	51.0	48.2	45.7	49.6	48.2	44.4	43.8				
Full Load	58.8	57.9	49.6	47.0	58.7	57.8	50.5	47.3				
Integrated dBA	57.7	56.2	49.2	46.6	57.2	56.2	49.2	46.4				
Outdoor @ 5 Feet				68.6								
Vent Option ERV	Low	Low	Low	Low	Low	Low	Low	Low				
Ventilation Only	53.9			48.9	52.6			45.2				
Full Load	54.8			49.3	55.0			56.3				
Integrated dBA	54.5			49.2	54.3			46.0				
Vent Option ERV	Med	Med	Med	Med	Med	Med	Med	Med				
Ventilation Only	55.0			50.3	54.4			45.9				
Full Load	55.5			50.7	56.1			41.4				
Integrated dBA	55.3			50.6	55.6			43.5				
Vent Option ERV	High	High	High	High	High	High	High	High				
Ventilation Only	56.7			49.3	56.0			46.4				
Full Load	57.2			49.7	57.8			47.0				
Integrated dBA	57.0			49.6	57.3			46.8				

¹ Integrated values calculated per ANSI/ASA S12.60-2009/Part 2, Section 5.2.2.1, Table 2 Triple Mode Type 3 HVAC System Duty Cycles: Ventilation 58%, Part Load 25%, Full Load 17%

² Integrated Sound Vales are also applicable for use in learning spaces for LEED schools; EQ Prerequisite 3 - Minimum Acoustical Performance, OPTION 1. Using methods prescribed in ANSI S12.60, classroom must achieve a maximum background noise level of 45 dBA.

Results Referenced Were Recorded In The Bard Manufacturing Company, Inc. Sound Lab Facility
Actual Field Application Results May Vary With Classroom Design and Construction Methods

Bard W60AA Series Sound Data Matrix (dBA @ 10 feet)

Bard	Duct Free				Ducted - Front Outlet							
	Unit Mounting	Direct	WMICF5 Isolation Curb	WMICF5 Isolation Curb	WMICF5 Isolation Curb	Direct	WMICF5 Isolation Curb	Direct	WMICF5 Isolation Curb			
Supply Air Treatment	Grille	Grille	Grille	WAPFB51 Free Blow Supply Plenum	Standard Supply Duct	Standard Supply Duct	Standard Supply Duct	WAPS51-G Supply Air Silencer				
Return Air Treatment	Grille	Grille	WAPR11-X Return Air Silencer	WAPR11-X Return Air Silencer	Grille	Grille	WAPR11-X Return Air Silencer	WAPR11-X Return Air Silencer				
Vent Option CRV	570 CFM	570 CFM	570 CFM	570 CFM	570 CFM	570 CFM	570 CFM	570 CFM				
Ventilation Only	51.3	50.1	47.8	44.6	49.1	42.2	47.7	41.2				
Full Load	56.0	53.5	48.6	45.6	55.7	48.3	52.5	43.9				
Integrated dBA	54.9	52.6	48.3	45.3	54.4	47.0	51.4	43.2				
Outdoor @ 10 Feet				67.4								
Sound Power Full Load	63.7			54.1	63.6			50.6				
Outdoor Sound Power					76.2							
Vent Option ERV	Low	Low	Low	Low	Low	Low	Low	Low				
Ventilation Only	53.4			45.0	52.1			42.8				
Full Load	56.7			46.7	55.2			46.5				
Integrated dBA	55.8			46.2	54.4			45.6				
Vent Option ERV	Med	Med	Med	Med	Med	Med	Med	Med				
Ventilation Only	54.7			45.1	53.9			43.4				
Full Load	57.6			47.5	56.8			48.5				
Integrated dBA	56.8			46.8	56.0			47.3				
Vent Option ERV	High	High	High	High	High	High	High	High				
Ventilation Only	56.7			45.5	56.4			43.6				
Full Load	58.9			47.0	58.6			48.5				
Integrated dBA	58.3			46.5	58.0			47.4				

Bard W60AA Series Sound Data Matrix (dBA @ 5 feet)

Bard	Duct Free				Ducted - Front Outlet							
	Unit Mounting	Direct	WMICF5 Isolation Curb	WMICF5 Isolation Curb	WMICF5 Isolation Curb	Direct	WMICF5 Isolation Curb	Direct	WMICF5 Isolation Curb			
Supply Air Treatment	Grille	Grille	Grille	WAPFB51 Free Blow Supply Plenum	Standard Supply Duct	Standard Supply Duct	Standard Supply Duct	WAPS51-G Supply Air Silencer				
Return Air Treatment	Grille	Grille	WAPR11-X Return Air Silencer	WAPR11-X Return Air Silencer	Grille	Grille	WAPR11-X Return Air Silencer	WAPR11-X Return Air Silencer				
Vent Option CRV	570 CFM	570 CFM	570 CFM	570 CFM	570 CFM	570 CFM	570 CFM	570 CFM				
Ventilation Only	54.3	52.0	48.4	47.1	51.6	44.6	50.8	43.4				
Full Load	59.4	57.0	49.2	48.4	59.2	50.0	56.7	47.4				
Integrated dBA	58.2	55.9	48.9	48.0	57.8	48.8	55.4	46.4				
Outdoor @ 5 Feet				69.9								
Vent Option ERV	Low	Low	Low	Low	Low	Low	Low	Low				
Ventilation Only	56.1			47.9	55.3			45.5				
Full Load	59.0			48.8	58.1			48.7				
Integrated dBA	58.2			48.5	57.3			47.9				
Vent Option ERV	Med	Med	Med	Med	Med	Med	Med	Med				
Ventilation Only	57.2			48.2	57.0			46.1				
Full Load	60.1			49.0	59.7			49.8				
Integrated dBA	59.3			48.7	59.0			48.9				
Vent Option ERV	High	High	High	High	High	High	High	High				
Ventilation Only	59.5			48.8	59.8			46.6				
Full Load	61.6			49.4	61.4			50.4				
Integrated dBA	61.0			49.2	60.9			49.4				

¹ Integrated values calculated per ANSI/ASA S12.60-2009/Part 2, Section 5.2.2.1, Table 2 Triple Mode Type 3 HVAC System Duty Cycles: Ventilation 58%, Part Load 25%, Full Load 17%

² Integrated Sound Values are also applicable for use in learning spaces for LEED schools; EQ Prerequisite 3 - Minimum Acoustical Performance, OPTION 1. Using methods prescribed in ANSI S12.60, classroom must achieve a maximum background noise level of 45 dBA.

Results Referenced Were Recorded In The Bard Manufacturing Company, Inc. Sound Lab Facility
Actual Field Application Results May Vary With Classroom Design and Construction Methods

Bard W72AA Series Sound Data Matrix (dBA @ 10 feet)

Unit Mounting	Duct Free				Ducted - Front Outlet							
	Direct	WMICF5 Isolation Curb	WMICF5 Isolation Curb	WMICF5 Isolation Curb	Direct	WMICF5 Isolation Curb	Direct	WMICF5 Isolation Curb				
Supply Air Treatment	Grille	Grille	Grille	WAPFB51 Free Blow Supply Plenum	Standard Supply Duct	Standard Supply Duct	Standard Supply Duct	WAPS51-G Supply Air Silencer				
Return Air Treatment	Grille	Grille	WAPR11-X Return Air Silencer	WAPR11-X Return Air Silencer	Grille	Grille	WAPR11-X Return Air Silencer	WAPR11-X Return Air Silencer				
Vent Option CRV	570 CFM	570 CFM	570 CFM	570 CFM	570 CFM	570 CFM	570 CFM	570 CFM				
Ventilation Only	53.1	52.3	50.2	44.6	51.6	45.9	50.7	45.6				
Full Load	58.9	57.5	51.5	48.2	58.2	48.5	57.1	47.4				
Integrated dBA	57.6	56.3	51.1	47.3	56.9	47.8	55.8	46.9				
Outdoor @ 10 Feet				71.9								
Sound Power Full Load	67.3			55.7	67.0			54.7				
Outdoor Sound Power					77.7							
Vent Option ERV	Low	Low	Low	Low	Low	Low	Low	Low				
Ventilation Only	54.2			45.4	52.2			43.5				
Full Load	55.6			48.2	55.4			45.1				
Integrated dBA	55.2			47.4	54.6			44.6				
Vent Option ERV	Med	Med	Med	Med	Med	Med	Med	Med				
Ventilation Only	54.6			45.7	53.8			43.9				
Full Load	56.3			48.1	56.3			45.7				
Integrated dBA	55.8			47.4	55.6			45.2				
Vent Option ERV	High	High	High	High	High	High	High	High				
Ventilation Only	55.4			45.7	54.9			44.1				
Full Load	57.2			47.9	57.2			45.9				
Integrated dBA	56.7			47.3	56.5			45.4				

Bard W72AA Series Sound Data Matrix (dBA @ 5 feet)

Unit Mounting	Duct Free				Ducted - Front Outlet							
	Direct	WMICF5 Isolation Curb	WMICF5 Isolation Curb	WMICF5 Isolation Curb	Direct	WMICF5 Isolation Curb	Direct	WMICF5 Isolation Curb				
Supply Air Treatment	Grille	Grille	Grille	WAPFB51 Free Blow Supply Plenum	Standard Supply Duct	Standard Supply Duct	Standard Supply Duct	WAPS51-G Supply Air Silencer				
Return Air Treatment	Grille	Grille	WAPR11-X Return Air Silencer	WAPR11-X Return Air Silencer	Grille	Grille	WAPR11-X Return Air Silencer	WAPR11-X Return Air Silencer				
Vent Option CRV	570 CFM	570 CFM	570 CFM	570 CFM	570 CFM	570 CFM	570 CFM	570 CFM				
Ventilation Only	56.6	55	52.5	47.2	54.9	48.2	53.7	47.7				
Full Load	63.4	61.8	54.5	52.3	63.5	53.3	61.8	52.3				
Integrated dBA	62.0	60.4	53.9	51.1	62.0	52.1	60.3	51.2				
Outdoor @ 5 Feet				73.0								
Vent Option ERV	Low	Low	Low	Low	Low	Low	Low	Low				
Ventilation Only	57.2			48.3	56.0			46.3				
Full Load	59.0			51.4	59.2			50.6				
Integrated dBA	58.5			50.6	58.4			49.6				
Vent Option ERV	Med	Med	Med	Med	Med	Med	Med	Med				
Ventilation Only	57.8			48.7	57.2			47.0				
Full Load	60.2			51.2	60.2			50.9				
Integrated dBA	59.5			50.5	59.4			49.9				
Vent Option ERV	High	High	High	High	High	High	High	High				
Ventilation Only	58.8			48.8	58.6			47.5				
Full Load	61.0			51.3	61.1			50.8				
Integrated dBA	60.4			50.6	60.4			49.9				

¹ Integrated values calculated per ANSI/ASA S12.60-2009/Part 2, Section 5.2.2.1, Table 2 Triple Mode Type 3 HVAC System Duty Cycles: Ventilation 58%, Part Load 25%, Full Load 17%

² Integrated Sound Values are also applicable for use in learning spaces for LEED schools; EQ Prerequisite 3 - Minimum Acoustical Performance, OPTION 1. Using methods prescribed in ANSI S12.60, classroom must achieve a maximum background noise level of 45 dBA.

Results Referenced Were Recorded In The Bard Manufacturing Company, Inc. Sound Lab Facility
Actual Field Application Results May Vary With Classroom Design and Construction Methods

Air Conditioning Wall-Mount Model Nomenclature

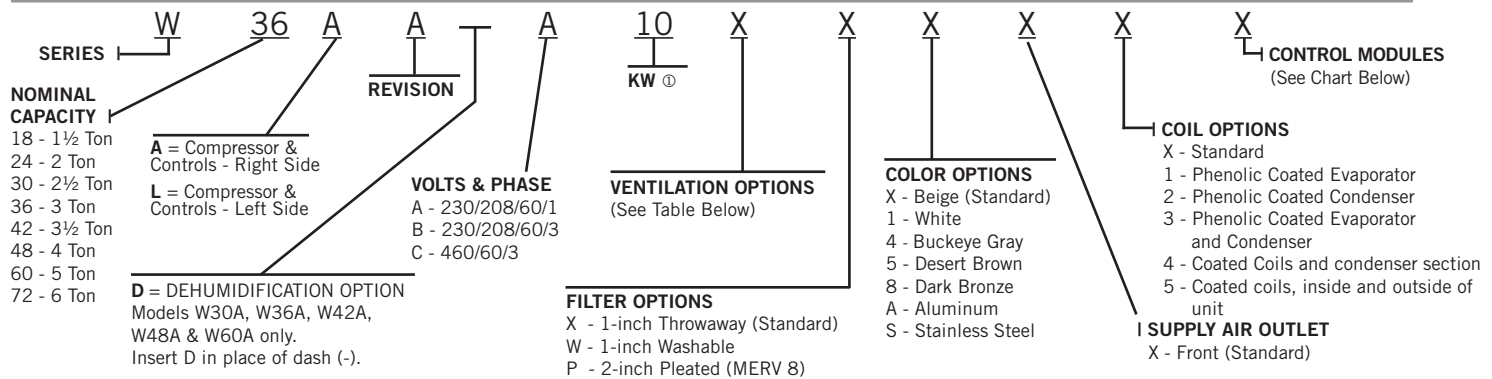

① For OKW and circuit breakers (230/208 Volt) or toggle disconnects (460 Volt) applications, insert OZ in the KW field of the model number. See Pages 8 & 9 for available Factory Installed KW options and Page 11 for Field Installed Heater Packages.

Ventilation Options

Models	W18AA, W24AA W18LA, W24LA		W30AA, W36AA W30LA, W36LA		W42AA, W48AA, W60AA W42LA, W48LA, W60LA		W72AA W72LA	
	Factory Inst. Code No.	Field Inst. Part No.	Factory Inst. Code No.	Field Inst. Part No.	Factory Inst. Code No.	Field Inst. Part No.	Factory Inst. Code No.	Field Inst. Part No.
Barometric Fresh Air Damper - Standard	X	BFAD-2	X	BFAD-3	X	BFAD-5	X	BFAD-5
Blank-Off Plate	B	BOP-2	B	BOP-3	B	BOP-5	B	BOP-5
Motorized Fresh Air Damper w/Plug	M	WMFADP2	M	WMFADP3	M	WMFADP5	M	WMFADP5
Commercial Ventilator - Spring Return	C	WCRVPS2P-* ④	C	WCRVPS3P-* ④	C	WCRVPS5P-* ④	C	WCRVPS6P-* ④
Economizer w/Plug, Temp Only ③	Y	WECOPT2-* ②	Y	WECOPT3-* ②	Y	WECOPT5-* ②	Y	WECOPT5-* ②
Economizer w/Plug, Enthalpy ③	Z	WECOPE2-* ②	Z	WECOPE3-* ②	Z	WECOPE5-* ②	Z	WECOPE5-* ②
Energy Recover Ventilator w/Plug, 230 ①	R ⑤	WERVPA2-* ②	R ⑤	WERVPA3-* ②	R ⑤	WERVPA5-* ②	R ⑤	WERVPA5-* ②
Energy Recover Ventilator w/Plug, 460 ①	R ⑤	WERVPC2-* ②	R ⑤	WERVPC3-* ②	R ⑤	WERVPC5-* ②	R ⑤	WERVPC5-* ②

- ① Intake and exhaust can be independently adjusted.
- ② Insert color to match unit ("X" = Beige; "4" = Buckeye Gray; etc.)
- ③ All Economizer versions have 7" deep intake hood.
- ④ Commercial Ventilator does not have 7" deep intake hood.
- ⑤ Energy Recovery Ventilator must be field-installed on W**L models.

Air Conditioning Control Modules

Air Conditioning Control Modules									All Models Except As Noted	
HPC ①	LPC ②	CCM ③	LAC ④	ALR ⑤	SK ⑥	SK ⑦	ODT ⑧	DDC ⑨	Factory Installed Code	Field Installed Part
STD	STD	STD							X	N/A
STD	STD	STD	•						E	CMA-28
STD	STD	STD	•						E	CMA-33 for W18 & W24 Only
STD	STD	STD	•	•					J	Factory Only
STD	STD	STD	•	•	•				K	CMC-15 and CMA-28 ⑩
STD	STD	STD	•	•	•				M	Factory Only
STD	STD	STD			•				Field Installed Only	CMC-15
STD	STD	STD					•		Field Installed Only	CMA-14
STD	STD	STD	•	•				•	V ⑪	Factory Only
STD	STD	STD						•	Field Installed Only	CMA-31 for W18-36 CMA-30 for W42-72
STD	STD	STD				•			Field Installed Only	SK111 Except W60 & 72 SK121 W72 Only SK122 W60 Only

STD = Standard equipment for these specified models.

- ① HPC. High pressure control is auto reset. Always used with compressor control module (CCM) which is included. See note ③.
- ② LPC. Low pressure control is auto reset. Always used with compressor control module (CCM) which is included. See note ③.
- ③ CCM. Compressor control module has adjustable 30-second to 5-minute delay-on-break timer. On initial power-up, or any time the power is interrupted, the delay-on-make will be 2-minutes plus 10% of the delay-on-break setting. There is no delay-on-make during routine operation of the unit. The module also provides the lockout feature (with 1 retry) for high and/or low pressure controls, and a 2-minute timed bypass for low-pressure control.
- ④ LAC. Low ambient control permits cooling operation down to 0°F. LAC is fan-cycling control for outdoor fan motor on all models except W18 & W24 units, which have modulating control.
- ⑤ ALR. The alarm relay has a set of normally open and normally closed dry contacts to provide the ability to signal a condition of shutdown on either high or low pressure controls.
- ⑥ SK. PTCR start kit can be used with all -A single phase models. Increases starting torque 2-3x. Not used for -B or -C three phase models. Do not use if SK111 or SK121 is used.
- ⑦ SK. Start capacitor & potential relay start kit can be used with all -A single phase models. Increases starting torque 9x. Not used for -B or -C three phase models. Do not use if CMC-15 is used.
- ⑧ ODT. Outdoor thermostat is adjustable from 0 to 50°F. It is suitable for use as a compressor cut-off thermostat.
- ⑨ DDC. Incorporates 4 additional sensors: discharge air temperature, indoor blower airflow, compressor current, and dirty filter. These sensing devices function to input analog data such as temperature, as well as digital data such as airflow, compressor status or filter status. Special economizer required; consult factory.
- ⑩ "V" control module for use with field-supplied DDC. Refer to "V" Module document F1605 for more information.
- ⑪ W18AA & W24AA units use modulating LAC kit CMA-33



Bard Manufacturing Company, Inc.
Bryan, Ohio 43506
www.bardhvac.com

Due to our continuous product improvement policy, all specifications subject to change without notice.

Before purchasing this appliance, read important energy cost and efficiency information available from your retailer.

Form No. S3502 September 2017
Supersedes S3502-217

Form No. S3502-1017
Supersedes S3502-217
Page 27 of 27